

Catalogue



Constant Superior Quality, Innovation in line with science and clinical practice

Intensiv is constantly committed to the development of innovative products such as Intensiv ZirconCut (p. 24-25) and the patented Intensiv Ortho-Strips System, Central (p. 96-97). Product development is significantly supported by close cooperation with experts in dentistry and leading university clinics. Always with an eye to providing ground-breaking solutions to the clinical challenges of practising dentists. Intensiv's consistently superior product quality is made possible by the selection of excellent raw materials and our unique industrial processes. 100% final piece control guarantees customers a product of the highest quality at all times.

























Intensiv products thus become the benchmark for excellence in terms of quality and functionality for preparation, finishing and polishing instruments. We are proud and thank you for choosing Intensiv for your instruments.

We are very pleased to count you among our customers and to be able to present you today with our new Intensiv catalogue 2023. We wish you interesting discoveries while reading this catalogue and much success in choosing your Intensiv instruments.

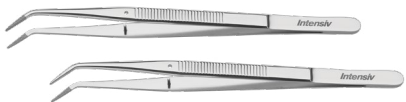

Günter Smailus
CEO Intensiv SA

Intensiv Specialities and Innovations

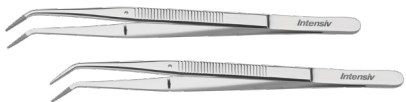
<p>Intensiv Swingle</p> <p>Pages 80-81 and 90-91</p>  <p>Intensiv Swingle</p> <p>Intensiv Swingle SWISS EDITION</p>	<p>Intensiv Guided Universal Prep Set</p> <p>Pages 14-15</p> 	<p>Intensiv Cutting Instruments</p> <p>Pages 70-71</p> 
<p>Intensiv Proxoshape</p> <p>Pages 84-85</p> 	<p>Intensiv OST400Set01/6</p> <p>Page 96</p> 	<p>Intensiv Ortho-Strips System, Central</p> <p>Pages 94-95</p> 
<p>Intensiv ZirconCut Prosthetics</p> <p>Pages 24-25</p> 	<p>Intensiv ProxoshapeTray</p> <p>Page 74</p> 	<p>Intensiv Ortho-StripsTray</p> <p>Page 75</p> 
<p>Intensiv IPR-DistanceControl</p> <p>Page 97</p> 	<p>Intensiv HygienicTray HT1000</p> <p>Page 73</p> 	<p>Intensiv HygienicTray HT2000</p> <p>Page 73</p> 
<p>Intensiv ProxoStrip</p> <p>Page 102</p> 	<p>Intensiv IPR Set</p> <p>Pages 98-99</p> 	<p>Intensiv PrepTwins</p> <p>Pages 100-101</p> 
<p>Intensiv ProxoStrip Plus</p> <p>Page 102</p> 	<p>Intensiv ProxoStrip Anterior</p> <p>Page 103</p> 	<p>Intensiv ProxoStrip Anterior</p> <p>Page 103</p> 
<p>Intensiv ProxoStrip Plus</p> <p>Page 102</p> 	<p>Intensiv ProxoContour Coarse</p> <p>Page 103</p> 	<p>Intensiv ProxoPolish</p> <p>Page 104</p> 
<p>Intensiv ProxoContour Coarse</p> <p>Page 103</p> 	<p>Intensiv ProxoPolish</p> <p>Page 104</p> 	<p>Intensiv DiaTweezer</p> <p>Page 106</p> 
<p>Intensiv UniglossPolisher</p> <p>Page 105</p> 	<p>Intensiv UniglossPaste</p> <p>Page 105</p> 	<p>Intensiv DiaTweezer</p> <p>Page 106</p> 

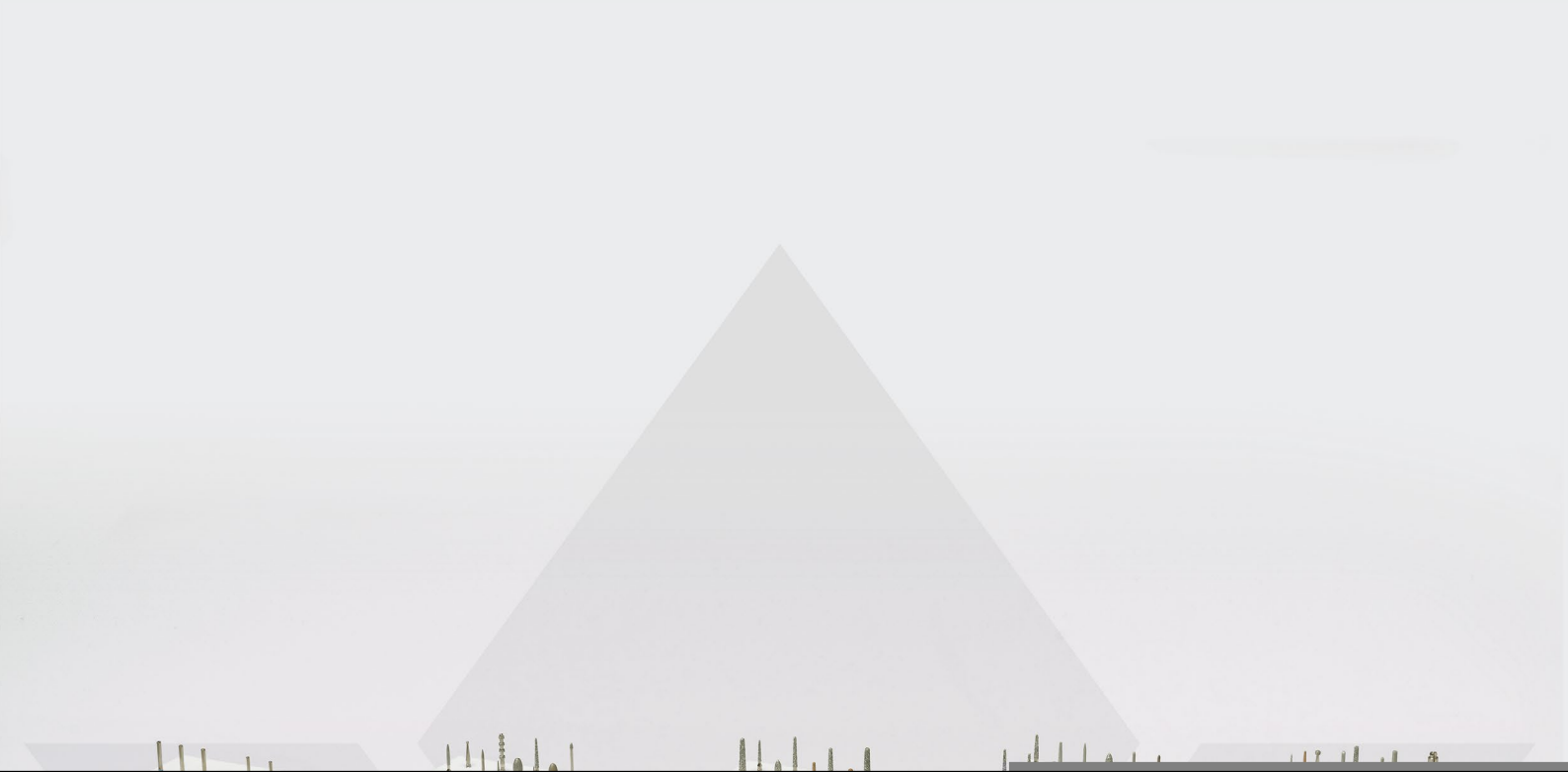

Intensiv Cons and Prosthetic Sets

Intensiv Cons Sets



Cons

Intensiv Cerinlay Set	6
Intensiv Minimal Invasiv Prep Set	7
Intensiv Composhape Set 1	8
Intensiv Composhape Set Anterior & Posterior	9
Intensiv Combi Prep Set: Direct Restoration	10
Intensiv Combi Prep Set: Contouring and Finishing Set	11
Intensiv Perio Set	12

Intensiv Cerinlay Set

Special diamond instruments for inlay cavity preparations

Restorations using ceramic inlays require simple preparations with rounded interior edges and sharp cavity margins without bevelling. The slightly tapered shape and suitable small diameters of these instruments make undercut-free cavity preparations possible.

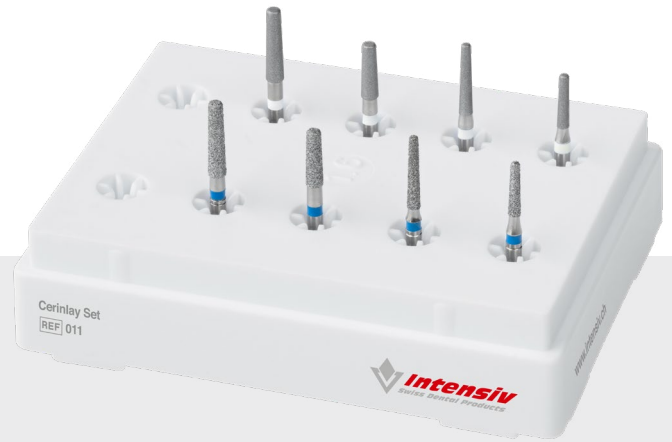

REF 011

Product Description

- 4 cones, rounded edges, Ø 014 and 018, 6.0 and 8.0 mm, 80 µm
- 4 shape and dimension matching instruments in 25 µm

Colour code	Micron	Description
524	80 µm	Medium
514	25 µm	Fine

LENGHT in mm } L

COLOUR CODE
Grit size indicator

R RADIUS in mm

Ø DIAMETER in ISO 1/10 mm

REF 011 - FG	R 0.28 L 6.0 Ø 014	R 0.20 L 8.0 Ø 014	R 0.28 L 6.0 Ø 018	R 0.28 L 8.0 Ø 018	R 0.28 L 6.0 Ø 014	R 0.28 L 8.0 Ø 014	R 0.28 L 6.0 Ø 018	R 0.28 L 8.0 Ø 018
FG 8425	FG 8427	FG 8525	FG 8526	FG 3425	FG 3427	FG 3525	FG 3526	FG 3526

Indications

- Preparation and finishing of ceramic inlay cavities for premolars and molars

University of Berlin, Germany



Benefits

- Preparation method clinically tested at the University of Berlin
- Finishing of fracture-free enamel margins
- Split-free marginal integration of inlays

Clinical pictures

- 01 Ceramic inlay cavity preparation with instrument FG 8526
- 02 Cavity finishing with instrument FG 3526
- 03 Cavity finishing with instrument FG 3525

Intensiv Minimal Invasiv Prep Set

Diamond instruments for minimally invasive restorations

Minimally invasive restoration techniques are designed to preserve healthy tooth substance. A defect-oriented procedure therefore requires preparation techniques with appropriately miniaturized instrument shapes.



REF 144

Product Description

- 1 cylinder, Ø 007, 2.0 mm, 40 µm
- 2 balls, Ø 007, with various neck lengths, 40 µm
- 1 wheel, Ø 015, 0.7 mm, 40 µm

Colour code	Micron	Description
■ 514	40 µm	Fine

LENGHT
in mm

COLOUR CODE
Grit size indicator

DIAMETER
in ISO 1/10 mm

REF 144 - FG	L 2.0 Ø 007	Ø 007	Ø 007	L 0.7 Ø 015
	■ FG 4612	■ FG 4199	■ FG 4699	■ FG 4610

Indications

Preparation of:

- Class I amalgam and composite fillings
- Classes II and III composite fillings
- Palatal fillings
- Tunnel preparations

Benefits

- Preservation of healthy tooth substance
- Preservation of marginal ridge in tunnel preparations
- Selective access
- No need of final polishing

University of Zurich, Switzerland



Clinical pictures

- 01 Depth control of the preparation with instrument FG 4612
- 02 Preparation of the palatal micro cavity with instrument FG 4610
- 03 Palatal opening and preparation of an anterior cavity with instrument FG 4610

Intensiv Composhape Set 1

Diamond instruments for modelling and finishing composite restorations

Contouring and finishing of composite fillings is an important step in restorative dentistry. Tooth substance must be preserved and enamel and filling fractures avoided to prevent infiltrations and secondary caries.

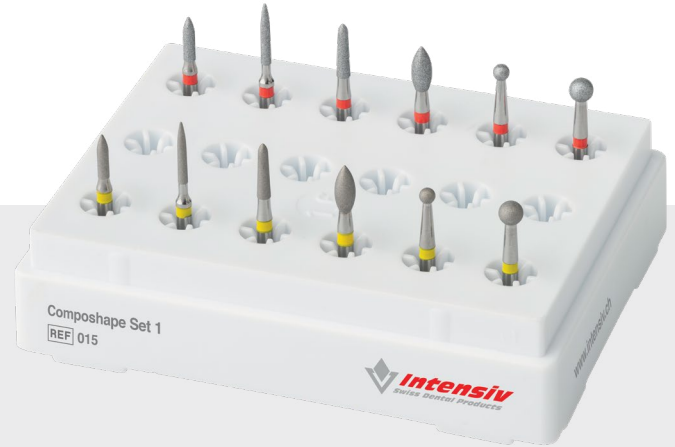



REF 015

Product Description

- 2 flames, Ø 010 and 012, 5 and 7 mm, 40 µm
- 1 torpedo, Ø 014, 6mm, 40 µm
- 1 football, Ø 021, 5mm, 40 µm
- 2 balls, Ø 017 and 024, 40 µm
- Shape and dimension matching instruments in 15 µm

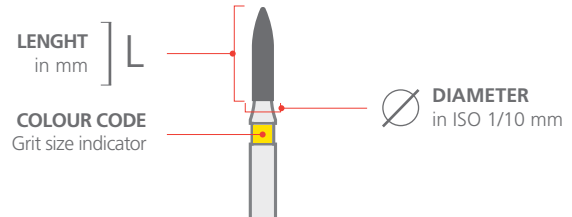
Colour code	Micron	Description
■ 514	40 µm	Fine
■ 504	15 µm	Extra fine



REF 015 - FG	L 5.0 Ø 012		L 7.0 Ø 010		L 6.0 Ø 014		L 5.0 Ø 021		Ø 017		Ø 024		All instruments are also available in RA 
	■ FG 4205	■ FG 4205L	■ FG 4062	■ FG 4255	■ FG 4201	■ FG 4400	■ FG 5205	■ FG 5205L	■ FG 5062	■ FG 5255	■ FG 5201	■ FG 5400	

Indications

- Contouring and finishing of:
- Composite fillings in anterior and posterior teeth
 - Extended fissure sealings with flowable composites
 - Enamel margins in adhesive preparation

Benefits

- Significant reduction of enamel and filling margin fractures
- Smooth filling surfaces ideally prepared for high gloss polishing

University of Zurich, Switzerland



Intensiv Composhape Set Anterior & Posterior

Instruments for all tooth morphologies. Fine grain for modelling, micro grain for smoother surfaces

Finishing of adhesive restorations must be non-destructive and tooth surfaces must be carefully prepared for final polishing. Use of these instruments preserves far more tooth substance compared to conventional finishing instruments. Fractures of enamel and composite margins are significantly less common. A greater amount of perfect margins is therefore produced.

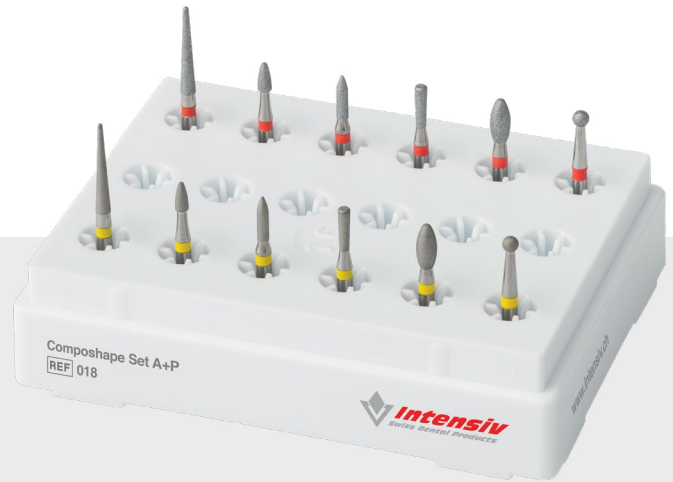

REF 018

Product Description

- 1 cone, round, Ø 016, 10 mm, 40 µm
- 2 flames, short and long, Ø 014 and 012, 3 and 5 mm, 40 µm
- 1 pear, long, Ø 013, 40 µm
- 1 football, Ø 021, 40 µm
- 1 ball, Ø 017, 40 µm
- Shape and dimension matching instruments in 15 µm

Colour code	Micron	Description
514	40 µm	Fine
504	15 µm	Extra fine

LENGHT
in mm

L

DIAMETER
in ISO 1/10 mm

COLOUR CODE
Grit size indicator

Instrument	Length (L)	Diameter (Ø)	Color Code	Part Number
Cone	10.0	016	Red	FG 4236
Flame (Short)	3.0	014	Red	FG 4274
Flame (Long)	5.0	012	Red	FG 4205
Pear	4.5	013	Red	FG 4223
Football	5.0	021	Red	FG 4250
Ball	-	017	Red	FG 4201
Cone	10.0	016	Yellow	FG 5236
Flame (Short)	3.0	014	Yellow	FG 5274
Flame (Long)	5.0	012	Yellow	FG 5205
Pear	4.5	012	Yellow	FG 5223
Football	5.0	021	Yellow	FG 5250
Ball	-	017	Yellow	FG 5201

All instruments are also available in RA

Indications

Finishing of:

- Composite fillings in anterior and posterior teeth
- Composite and ceramic inlays and veneers
- Extended fissure sealings with flowable composites
- Enamel margins in adhesive preparations

Benefits

- Significant reduction of enamel and filling margin fractures
- Perfectly smooth filling surfaces ideally prepared for the high gloss polishing

University of Zurich, Switzerland



Intensiv Combi Prep Set: Direct Restoration

Diamond instruments for direct tooth-coloured adhesive restorations

Direct restoration techniques require preparations that give primary importance to efficiency and precision. The definitive fracture-free preparation of margins plays a key role in finishing, particularly in the case of adhesive restorations. This makes the rotating and oscillating instruments designed for use with these techniques an essential aid.



REF 133

Product Description

- 4 cylinders, Ø 010 and 014, 5 mm, 80 and 25 µm
- 1 cylinder, Ø 009, 3 mm, 80 µm
- 2 balls, Ø 010 and 012, 80 µm
- 3 flames, short and long, Ø 010 and 012, 40 and 8 µm
- 1 Intensiv Proxoshape file PS2, 40 µm
- 1 ball, Ø 024, 40 µm

Colour code	Micron	Description
524	80 µm	Medium
514	40 µm	Fine
514	25 µm	Fine
494	8 µm	Ultra fine

Instrument	Length (L)	Diameter (Ø)	Grain Size	Code
FG 8714	5.0	014	80 µm	Blue
FG 3714B	5.0	014	25 µm	White
FG 8710	5.0	010	80 µm	Blue
FG 3710B	5.0	010	25 µm	White
FG 8212S	3.0	009	80 µm	Blue
FG 8200	-	012	80 µm	Blue
FG 8200S	-	010	80 µm	Blue
FG 4205	5.0	012	40 µm	Red
FG 9205	5.0	012	8 µm	Orange
FG 4205L	7.0	010	40 µm	Red
PS2	8.50	-	40 µm	Red
FG 4400	-	024	40 µm	Red

Indications

- Preparation of cavities for aesthetic adhesive fillings in anterior and posterior teeth

Benefits

- Sharp-edged and fracture-free margins
- Invisible tooth-coloured restorations
- Method clinically tested by the University of Zurich

University of Zurich, Switzerland



Intensiv Combi Prep Set: Contouring and Finishing Set

Diamond instruments for finishing
of aesthetic restorations

In current restoration techniques, the quality of the generated surface is the key factor at the contouring and finishing stage. For this reason, the rotating and oscillating instruments developed for these techniques are essential.



REF 135

Product Description

- 1 ball, Ø 033, 8 µm
- 4 flames, Ø 012, 013 and 014, 3 and 5 mm, 40 and 8 µm
- 1 cylinder, Ø 011, 10 mm, 8 µm
- 1 football, Ø 022, 5 mm, 80 µm
- 2 Intensiv Proxoshape files, PS2S and PS9S, 40 and 8 µm
- 2 Intensiv Rootshape files, RS40 and RS9, 40 and 8 µm

Colour code	Micron	Description
524	80 µm	Medium
514	40 µm	Fine
494	8 µm	Ultra fine

Instrument	Length (mm)	Diameter (mm)	Code
Ball	5.0	0.33	FG 9401
Flame 1	5.0	0.12	FG 4205
Flame 2	5.0	0.12	FG 9205
Flame 3	3.0	0.14	FG 4274
Proxoshape 1	8.5	-	PS2S
Proxoshape 2	8.5	-	PS9S
Rootshape 1	3.0	-	RS40
Rootshape 2	3.0	-	RS9
Cylinder	10.0	0.11	FG 9040
Football	5.0	0.22	FG 8255
Football	3.0	0.13	FG 9274

Indications

- Finishing of adhesive restorations in the anterior and posterior areas

Benefits

- Exact contouring of composite margins
- Creation of fine composite surfaces ideally prepared for final polishing
- Method clinically tested by the University of Zurich

University of Zurich, Switzerland

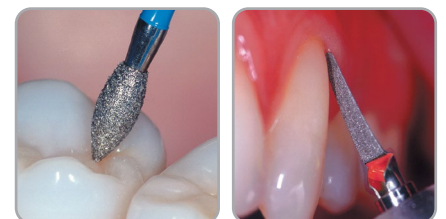

Intensiv Perio Set

Diamond instruments for odontoplasty and mechanical root planing in periodontal treatments

Some important interventions in the treatment of periodontitis include the cleaning and polishing of the root surface. Supragingival and subgingival plaque as well as calculus and superficial endotoxin-containing cementum layers must be thoroughly removed. These are absolute preconditions for the complete healing and regeneration of the periodontal tissue.



Product Description

- The coarse 75 µm burs are used only in odontoplasty
- The fine grit 40 µm burs are used for depuration of root surfaces
- The 15 µm burs are used for the final planing

REF 045, Intensiv Perio Set.
All Diamond instruments are available in packages of 1, 3 or 6 pcs

Colour code	Micron	Description
524	80 µm	Medium
514	40 µm	Fine
504	15 µm	Extra fine

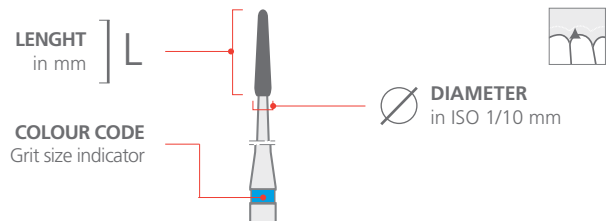

<p>REF 045 – 831L – RA</p>	<p>REF 045 – 832L – RA</p>
<p>REF 045 – 831 – RA</p>	<p>REF 045 – 832 – RA</p>

Indications

- Mechanical removal of supragingival and subgingival concretions
- Periodontal surgery (depuration of exposed root surfaces)
- Root planing
- Odontoplasty

Benefits

- Homogeneous smooth root surfaces

Prof. K.H. Rateitschak, Basel, Switzerland



Intensiv Prosthetic Sets

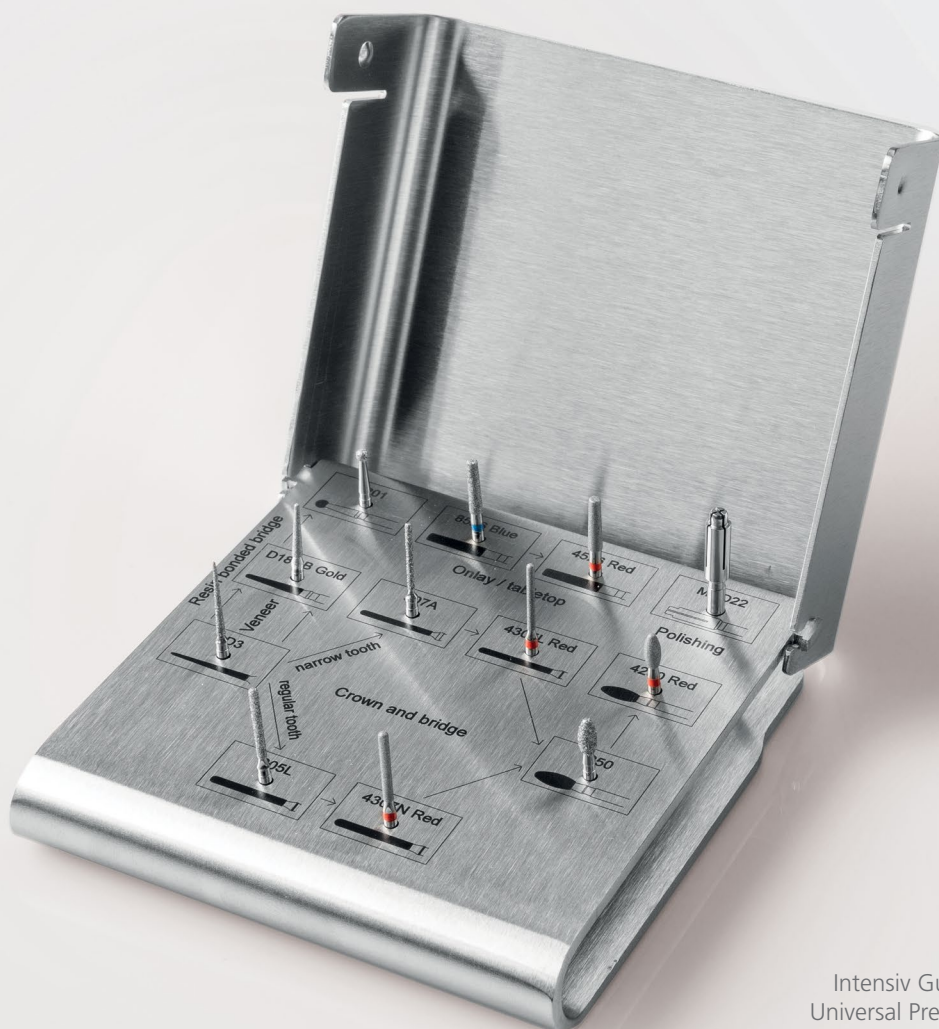

Intensiv Guided
Universal Prep Set

Prosthetic

Intensiv Guided Universal Prep Set	14
Intensiv Sets Direct and Indirect Anterior & Posterior	16
Intensiv Advanced Prep & Finishing Set for Cerec Restorations	18
Intensiv Universal full Crown and Porcelain Veneer Prep Set	20
Intensiv Tooth Caring Bur Set	21
Intensiv Modular Veneer Set	22
Intensiv Geneva Prep Set	23
Intensiv ZirconCut Prosthetics	24

Intensiv Guided Universal Prep Set

Innovative Prep set in stainless steel tray.
An imprinted diagram guides through the current preparation methods of modern reconstructive dentistry

A precise, tissue conserving preparation for the manufacture of veneers, inlays, overlays, tabletops and adhesive bridges is permanently secured through this perfected, goal-oriented set of rotating and oscillating diamond instruments in the desired highest quality.

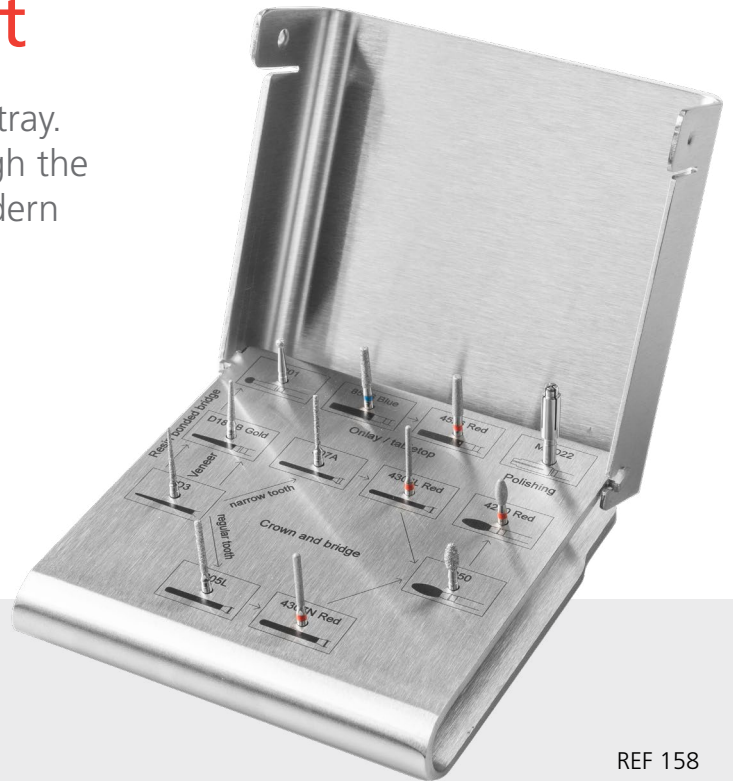

REF 158

Product Description

TRAY:

- Two-pieces stainless steel tray, consisting of a base, connected to a detachable lid
- Dimensions: l 77 mm, w 75 mm, h 31 mm
- The tray is printed with a diagram as well as pictograms of the instruments for structured guidance through the clinical applications

INSTRUMENTS:

- 1 cone, pointed, \varnothing 012, 11 mm, 80 μ m
- 4 cylinders, x-long, round, \varnothing 012, 013, 011 and 011, 10 mm, 90 and 40 μ m
- 1 ball, \varnothing 018, 90 μ m
- 2 cones, rounded edge, \varnothing 018, 8 mm, 80 and 40 μ m
- 2 footballs, \varnothing 023 and 021, 5 mm, 106 and 40 μ m
- 1 cone, round, \varnothing 016, 8 mm, 50 μ m

Colour code	Micron	Description
524	106 μ m	60/80/90 μ m* Standard
524	80 μ m	Medium
514	50 μ m	Golden Burs GB
514	40 μ m	Fine

*Depending on the shape and size of the instruments, the grit size may differ from the specified value.

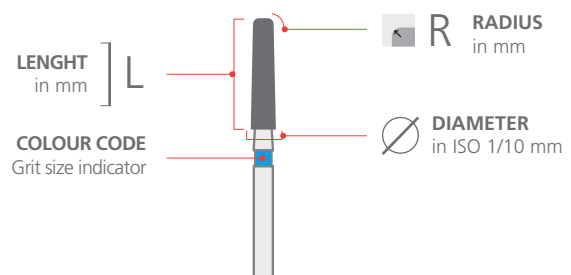

REF 158 - FG	 L 11.0 Ø 012 FG D3	 L 10.0 Ø 012 FG 305L	 L 10.0 Ø 013 FG 4307N	 L 10.0 Ø 011 FG 307A	 L 10.0 Ø 011 FG 4305L	 Ø 018 FG 201	 R 0.28 L 8.0 Ø 018 FG 8526	 R 0.28 L 8.0 Ø 018 FG 4526
	 L 5.0 Ø 023 FG 250	 L 5.0 Ø 021 FG 4250	 L 8.0 Ø 016 FG D18GB	 MRD22				

Indications

- Veneer preparation
- Crown preparation
- Full ceramic reconstructions
- Reconstructions with zirconium oxide ceramic
- Optical impression and CAD/CAM
- From minimal-invasive to conventional preparation technique

Zentrum für Zahnmedizin ZMZ Zurich,
Switzerland



Classic veneer

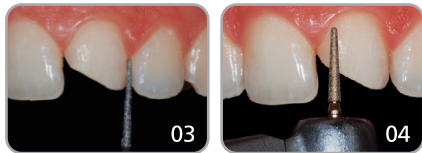

Additional veneer (purely defect-oriented preparation)

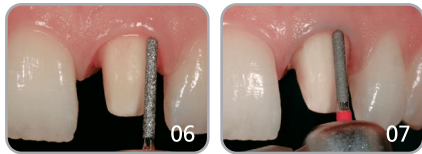

Full crown preparation

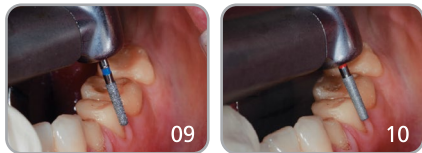
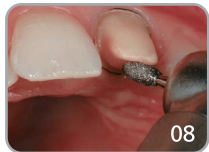

Partial crown, overlay (tabletop) preparation



Adhesive bridge preparation

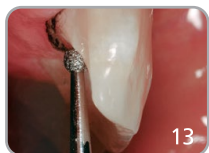

Benefits

- Clearly defined and effective application of diamond instruments, thanks to the diagram printed on the tray chart with a recommended sequence of instruments and their grits
- Unique, innovative prep set for all types of modern reconstruction
- Secure identification and storage of instruments
- The tray can be sterilized by a validated method

Clinical pictures

- 01 Before preparation, an ultra-fine retraction thread was placed in the sulcus to protect the gingival margin. Interdental preparation with separation instrument FG D3
- 02 Axial reduction with veneer preparation instrument FG D18GB, 0.5mm wide shoulder preparation
- 03 Interdental defect-oriented preparation with separation instrument FG D3
- 04 Axial reduction with veneer preparation instrument FG D18GB, tapered edge
- 05 Veneer detail
- 06 Shoulder preparation on tooth 21: placing of an ultra thin thread, interdental separation with separation instrument FG D3, 1mm wide circular internally rounded shoulder preparation with shoulder instrument FG 305L. The preparation set includes a narrow shoulder preparation instrument FG 307A for narrow tooth stumps and tight spaces
- 07 Palatal concavity with frontside rounded football instrument FG 250
- 08 Finishing of the shoulder and axial walls: the stump is smoothed with the newly developed - analogous to the dimensions of the preparation instrument - cylindrical finishing instrument FG 4307N (wide)
- 09 Defect-oriented overlay (tabletop) preparation on a patient with dentition damaged by erosion and abrasion, rough preparation with preparation instrument FG 8526, occlusal preparation with football instrument FG 250
- 10 Finishing with appropriate finishing instruments FG 4526 and FG 4250, posterior breaking of all sharp edges with abrasive discs clamped into the mandrel
- 11 Definition of a mesial and distal groove in the enamel in the desired direction of insertion, slightly palatal to the future contact point, with separation instrument FG D3
- 12 Expansion of groove in the enamel with conical veneer preparation instrument FG D18GB, thereby fulfilling currently valid requirements for full ceramic and CAD/CAM production (apically rounded, 6° conicity, clear groove definition)
- 13 Preparation of a cingulum support in the enamel with ball instrument FG 201

Intensiv Sets Direct and Indirect Anterior & Posterior

Diamond instruments for anterior and posterior direct and indirect restorations

Aesthetic direct and indirect restorations play a predominant role in modern dentistry and represent a new limit between the conservative dentistry and the prosthesis for recovering individual elements. A complete set of instruments for all clinical indications in the field of direct and indirect aesthetic restorations, is selected.



REF 202PI

Product Description

3 sets with 8 diamond-coated instruments each, placed in the Intensiv HygienicTray HT1000.

REF 202PI

Posterior indirect restorations

- 1 cone, Ø 012, 8 mm, 80 µm
- 4 cones, Ø 014, 8 mm, 80 and 25 µm grits
- 1 cone, Ø 020, 4 mm, 25µm
- 2 cones, Ø 018, 6 mm, 80 and 25 µm

REF 202PD

Posterior direct restorations

- 1 cylinder, Ø 009, 3 mm, 80 µm
- 4 cylinders, Ø 011 and 013, 6 mm, 80 and 25 µm
- 2 cylinders, Ø 014, 6 mm, 80 and 25 µm
- 1 flame, Ø 014, 7 mm, 40 µm

REF 202ADI

Anterior direct and indirect restorations

- 1 ball, Ø 009, 60 µm
- 2 balls, Ø 014, 90 and 40 µm
- 2 balls, Ø 023, 106 and 40 µm
- 2 cylinders, rounded end, Ø 012, 10 mm, 90 and 40 µm
- 1 flame, Ø 010, 7 mm, 40 µm

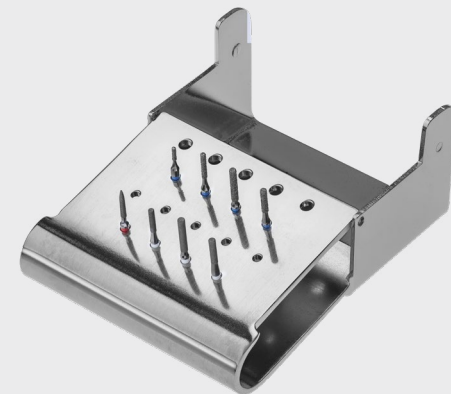

REF 202PD

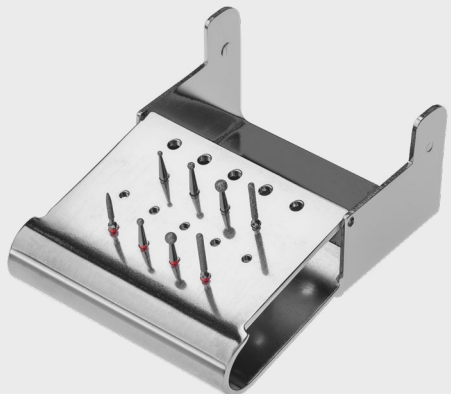

REF 202ADI

Indications

- Preparation of cavities for direct and indirect restorations in anterior and posterior areas
- Conservative preparations with perfectly finished cavity walls and margins

Benefits



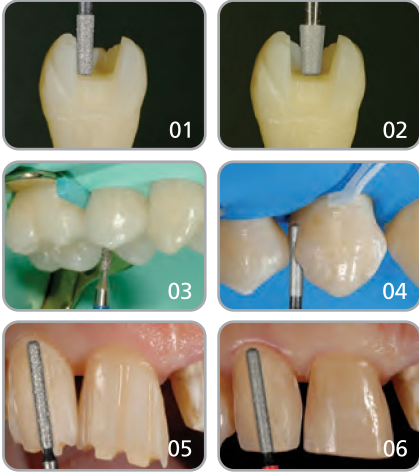

- Placed in Intensiv HygienicTray (HT1000) instrument holders, to facilitate the identification and the organization of the sets
- Possible individualisation of the sets with additional instrument insertion (oscillating instruments, rubber cups etc.) thanks to the 13 FG and 5 RA holes in the tray
- Form and size congruence between the preparation and finishing instruments

Dr. Roberto Spreafico, Busto Arsizio, Italy











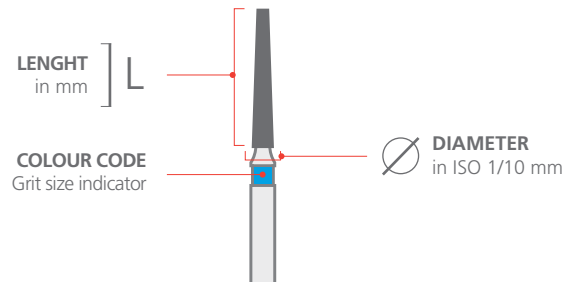















Clinical pictures

- 01 FG 8525: preparation of the walls
- 02 FG 3413R: finishing of the occlusal surface
- 03 FG 8212S: opening of the cavity for direct restorations
- 04 FG 3514/3614B/3414B: finishing of the margins
- 05 FG 305L: production of vestibular guiding grooves and preparation of incisal margin
- 06 FG 4307N: finishing of the preparation for veneers

Colour code	Micron		Description
 524	106 µm	60/80/90 µm*	Standard
 524	80 µm		Medium
 514	40 µm		Fine
 514	25 µm		Fine

*Depending on the shape and size of the instruments, the grit size may differ from the specified value.



REF 202PI – FG	 L 8.0 Ø 012 FG 116	 L 6.0 Ø 014 FG 8425	 L 8.0 Ø 014 FG 8427	 L 6.0 Ø 018 FG 8525	 L 4.0 Ø 020 FG 3413R	 L 6.0 Ø 014 FG 3425	 L 8.0 Ø 014 FG 3427	 L 6.0 Ø 018 FG 3527
REF 202PD – FG	 L 3.0 Ø 009 FG 8212S	 L 6.0 Ø 011 FG 8510	 L 8.0 Ø 014 FG 8614	 L 6.0 Ø 013 FG 8514	 L 7.0 Ø 010 FG 4205L	 L 6.0 Ø 011 FG 3514	 L 8.0 Ø 014 FG 3614B	 L 6.0 Ø 013 FG 3414B
REF 202ADI – FG	 Ø 009 FG 200S	 Ø 014 FG 201S	 Ø 023 FG 400S	 L 10.0 Ø 012 FG 305L	 L 7.0 Ø 010 FG 4205L	 Ø 012 FG 4201S	 Ø 021 FG 4400S	 L 10.0 Ø 013 FG 4307N

Intensiv Advanced Prep & Finishing Set for Cerec Restorations

Diamond instruments for inlays, partial and full crowns, and fixed restorations

Both instrument sets fulfil in an ideal manner all the requirements for superior multipurpose preparation and finishing goals created by Cerec 3 technology.

Product Description

Inlay cavities and partial crowns:

- 4 cylinders, rounded edges, Ø 011 and 014, 5, 6, and 8 mm, 80 and 25 µm
- 1 cone, rounded edges, Ø 018, 8 mm, 25 µm
- 1 cone, Ø 010, 8 mm, 25 µm

CROWN PREPARATION:

- 1 cone, Ø 012, 11 mm, 80 µm
- 2 cylinders, rounded edges, Ø 014, 10 mm, 80 and 25 µm
- 1 cone, rounded edges, Ø 016, 8.06 mm, 80 µm.
- 1 football, conical, Ø 022, 5 mm, 80 µm
- 1 football, Ø 021, 5 mm, 40 µm

FINISHING:

- 4 flares, Ø 012, 013, 014, 3 and 5 mm, 40 and 8 µm
- 1 ball, Ø 009, 60 µm
- 1 ball, Ø 012, 90 µm
- 2 balls, Ø 024, 40 and 8 µm
- 2 Intensiv Proxoshape Files PS2 and PS9, 40 and 8 µm



REF 222A



REF 222B

University of Zurich, Switzerland



Clinical pictures

- 01 Shoulder preparation on tooth 21: The circular shoulder is structured with a plane front face using FG 8422. Shoulder width approx. 0.8 mm
- 02 Finishing the preparation: the tooth stump is finished with FG 3614B
- 03 Preparation of chamfer on tooth 11: The circular chamfer is prepared with FG 8040
- 04 Finishing the preparation: the stump is finished with FG 3040B
- 05 Shoulder preparation: defect-oriented crown preparations on molars and premolars after finishing for adhesive attachment of full ceramic Cerec crowns
- 06 Veneer preparations on the lateral incisor teeth without inclusion of the incisal edges

Indications

- Cavity preparation for inlay and partial crowns and for full ceramic bridges in zirconium oxide
- Contouring and finishing of the CAD/CAM-generated occlusion

Benefits

- Precise cavity contours for optical identification
- Preservation of healthy tooth substance
- Prepolishing with reduced roughness depth
- Method clinically tested by the University of Zurich

Colour code	Micron	Description
524	106 µm	60/80/90 µm*
524	80 µm	Medium
514	40 µm	Fine
514	25 µm	Fine
494	8 µm	Ultra fine

*Depending on the shape and size of the instruments, the grit size may differ from the specified value.

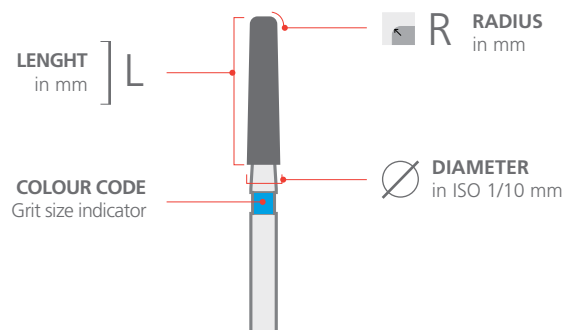

REF 222A – FG								
REF 222B – FG								

(*Intensiv Proxoshape, pages 84-85)

Intensiv Universal full Crown and Porcelain Veneer Prep Set

Diamond Instruments for crown and bridge prosthetic restorations

Often during prosthetic preparation it is necessary to follow a simple, accurate, repeatable and reliable method. The method created by Dr. Dazhaev, Moscow, in collaboration with Intensiv, allows for a structured process, thanks to the adequate selection of instruments and the production of special shapes, ensuring long-term outcome.

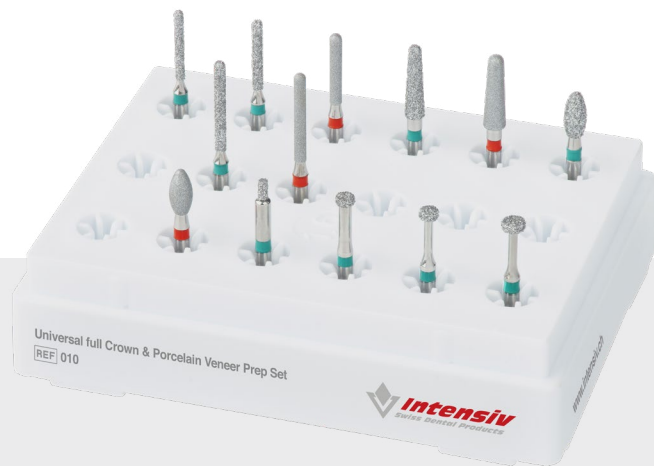

REF 010

Product Description

- 3 cylinders, round, Ø 010, 012 and 021, 8 mm, 125 µm
- 2 cylinders, round, Ø 013 and 022, 8 and 5 mm, 40 µm
- 2 egg-shaped instruments, Ø 023 and 022, 5 mm, 125 and 40 µm
- 2 cones, round, Ø 012 and 013, 10 mm, 125 and 40 µm
- 4 depth markers, 125 µm

Colour code	Micron		Description
534	125 µm	106 µm*	Coarse
514	40 µm		Fine

*Depending on the shape and size of the instruments, the grit size may differ from the specified value.

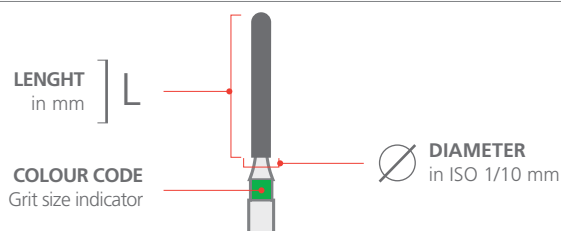

REF 010 – FG								

Indications

- Preparation of full crowns
- Preparation of porcelain veneers

Benefits

- Fast and very precise reduction
- Depth markers
- Very accurate crisp chamfer creation
- Composition of this set allows following both, classic and minimal invasive approach to preparation

Dr. G. Dazhaev, Moscow, Russia



Intensiv Tooth Caring Bur Set

Diamond instruments for lowering and finishing subgingival edge of cervical steps and shoulders of fixed prosthetic preparations without damaging adjacent teeth

This preparation method requires a set of special instruments to enable efficient and controlled substance removal. At the same time these instruments ensure perfectly finished surfaces of shoulders and margins for stumps in prosthetics.

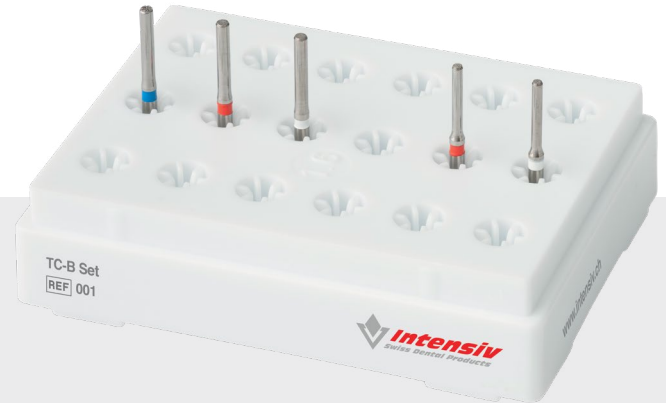

REF 001

Product Description

- 2 cylinders, rounded edges, end-coated only, Ø 011, 40 and 25 µm
- 3 shape and dimension matching instruments, Ø 014 in 80, 40 and 25 µm

Colour code	Micron	Description
524	80 µm	Medium
514	40 µm	Fine
514	25 µm	Fine

REF 001 – VB1 – FG	REF 001 – VB2 – FG
<ul style="list-style-type: none"> Ø 011 FG 01140 FG 01125 	<ul style="list-style-type: none"> Ø 014 FG 01480 FG 01440 FG 01425

Indications

- Preparation of shoulder margins and proximal box margins

Benefits

- Preservation of prepared stump and shoulder profiles
- Prevention of iatrogenic damage

University of Bern, Switzerland

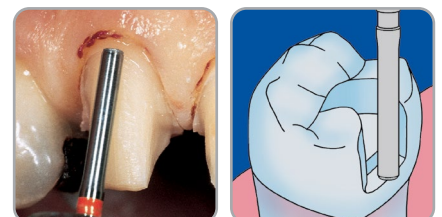

Intensiv Modular Veneer Set

Diamond instruments for Veneer preparations

Ceramic veneers are generally seen today as a minimal invasive and long lasting reconstruction form. Tooth preparation defined and restricted to the enamel is a prerequisite for permanent, tooth-friendly veneer placement.



REF 099

Product Description

- 1 ball, Ø 009, 60 µm
- 1 pilot instrument S4, depth specification of 0.4 mm labially
- 1 torpedo, Ø 014, 10 mm, 90 µm
- 1 torpedo, Ø 011, 2 mm, 40 µm
- 2 flames, Ø 010, 7 mm, 40 and 15 µm
- 2 footballs, Ø 029, 5.5 mm, 40 and 15 µm
- 2 cones pointed, Ø 008 and 007, 4 mm, 40 and 15 µm

Colour code	Micron		Description
524	106 µm	60/80/90 µm*	Standard
514	40 µm		Fine
504	15 µm		Extra fine

*Depending on the shape and size of the instruments, the grit size may differ from the specified value.

Instrument	Penetration depth	Length (L)	Diameter (Ø)	Color Code	FG
Ball	Ø 009			Grey	FG 200S
Pilot instrument S4	0.4 mm			Grey	FG S4
Torpedo		10.0	014	Grey	FG 101
Torpedo		2.0	011	Red	FG 4310S
Flame		7.0	010	Red	FG 4205L
Flame		7.0	010	Yellow	FG 5205L
Football		5.5	029	Red	FG 4259
Football		5.5	029	Yellow	FG 5259
Cone pointed		4.0	008	Red	FG 40D9
Cone pointed		4.0	007	Yellow	FG 50D9

Indications

- Preparation of veneers

Benefits

- Maintenance of the recommended penetration depth of 0.4 mm
- Complete instrument set for veneer preparation

Dr. A. Schöler, Biel, Switzerland

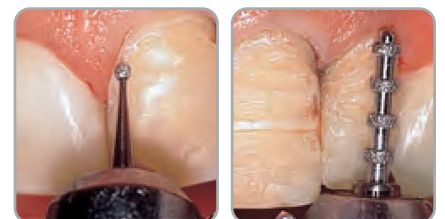

Intensiv Geneva Prep Set

Diamond instruments for crown and bridge prosthetic restorations

Instruments for classic crown and bridge restorations according to methods developed at the University of Geneva.



REF 055

Product Description

- 1 cone, round, Ø 012, 7 mm, 90 µm
- 2 cones, round, Ø 016 and 018, 10 and 8 mm, 106 µm
- 2 cones, round, Ø 022 and 023, 10 and 11 mm, 106 µm
- 1 football Ø 023, 5 mm, 106 µm
- 2 cones, round, Ø 016 and 024, 6 and 7 mm, 50 µm
- 1 football, Ø 016, 3 mm, 50 µm

Colour code	Micron		Description
524	106 µm	60/80/90 µm*	Standard
514	50 µm		Golden Burs GB

*Depending on the shape and size of the instruments, the grit size may differ from the specified value.

Instrument	Length (L) in mm	Diameter (Ø) in mm	FG Code
FG D16	7.0	012	524
FG D6	10.0	016	524
FG 235	8.0	018	524
FG 237	10.0	022	524
FG 240	11.0	023	524
FG 255	5.0	023	524
FG D8GB	6.0	016	514
FG D7GB	7.0	024	514
FG 274GB	3.0	016	514

Indications

- Stump preparation for crowns and bridges

Benefits

- Reduced number of instruments for complex preparation procedures
- Method tested by the University of Geneva

University of Geneva, Switzerland



Intensiv ZirconCut Prosthetics

Intensiv special diamond instruments for more efficient cutting of zirconia ceramic restorations

Cutting zirconia ceramic restorations is a major challenge in dental clinics today. The material is very compact and extremely hard. Adhesive cementation can lead to hardly removable anchorage of crowns and bridges. Intensiv ZirconCut special diamond instruments are suitable for more efficient cutting of zirconia ceramic restorations.

Product Description

- 3 stainless steel instruments with multiple diamond coating in diameter 014 or 016
- Diamond grit size: various sizes from coarse to fine
- Shapes:
 - Cylinder edged 90°, 6 mm
 - Cylinder round, 6 mm
 - Cylinder flame, 5 mm
- Colour: black (intensity may change)
- Sterilisable and reusable



Indications

- Separation of crowns and bridges made of zirconia ceramics or other ceramic materials



Dr. A. Devigus, Bülach, Switzerland



Benefits

- Cuts zirconia significantly faster
- Longer and constant higher cutting performance
- Scientific study at the Dental Clinic of the University of Zurich

Clinical pictures

- 01 Preparation for buccal cut of a premolar all-ceramic zirconia crown
- 02 Illustration of a premolar all-ceramic zirconia crown which was cut buccally and occlusally
- 03 Occlusal separation of a zirconia all-ceramic premolar crown
- 04 Illustration of a separated zirconia all-ceramic premolar crown

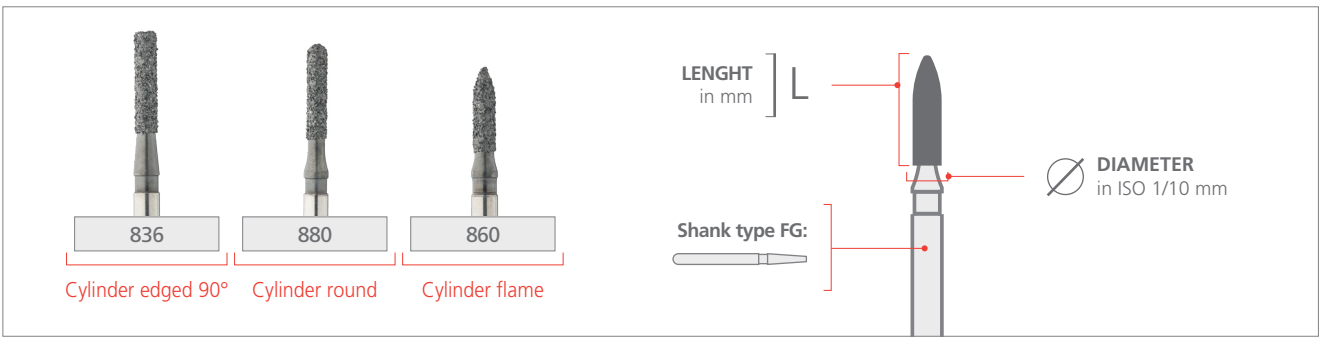

3 INSTRUMENTS IN STAINLESS STEEL TRAY

<p>Set with 3 different instruments: 1 cylinder edged 90°, 6 mm + 1 cylinder round, 6 mm + 1 cylinder flame, 5 mm</p>				<p>3 instruments: cylinder edged 90°, 6 mm</p>				<p>3 instruments: cylinder round, 6 mm</p>				<p>3 instruments: cylinder flame, 5 mm</p>			
Ø 014	REF ZrSet035A/3	L 6.0 Ø 014	L 6.0 Ø 014	L 5.0 Ø 014	REF FG Zr01/3	L 6.0 Ø 014	REF FG Zr02/3	L 6.0 Ø 014	REF FG Zr03/3	L 5.0 Ø 014					
		FG Zr01	FG Zr02	FG Zr03		FG Zr01		FG Zr02		FG Zr03					
Ø 016	REF ZrSet040A/3	L 6.0 Ø 016	L 6.0 Ø 016	L 5.0 Ø 016	REF FG Zr05/3	L 6.0 Ø 016	REF FG Zr06/3	L 6.0 Ø 016	REF FG Zr07/3	L 5.0 Ø 016					
		FG Zr05	FG Zr06	FG Zr07		FG Zr05		FG Zr06		FG Zr07					

6 INSTRUMENTS

<p>Set with 3 different instruments: 2 cylinder edged 90°, 6 mm + 2 cylinder round, 6 mm + 2 cylinder flame, 5 mm</p>				<p>6 instruments: cylinder edged 90°, 6 mm</p>				<p>6 instruments: cylinder round, 6 mm</p>				<p>6 instruments: cylinder flame, 5 mm</p>			
Ø 014	REF ZrSet035A/6	L 6.0 Ø 014	L 6.0 Ø 014	L 5.0 Ø 014	REF FG Zr01/6	L 6.0 Ø 014	REF FG Zr02/6	L 6.0 Ø 014	REF FG Zr03/6	L 5.0 Ø 014					
		FG Zr01	FG Zr02	FG Zr03		FG Zr01		FG Zr02		FG Zr03					
Ø 016	REF ZrSet040A/6	L 6.0 Ø 016	L 6.0 Ø 016	L 5.0 Ø 016	REF FG Zr05/6	L 6.0 Ø 016	REF FG Zr06/6	L 6.0 Ø 016	REF FG Zr07/6	L 5.0 Ø 016					
		FG Zr05	FG Zr06	FG Zr07		FG Zr05		FG Zr06		FG Zr07					

Shapes Chart

Intensiv Diamond Instruments

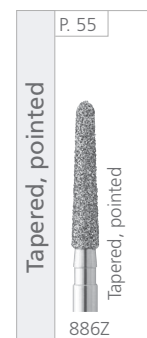
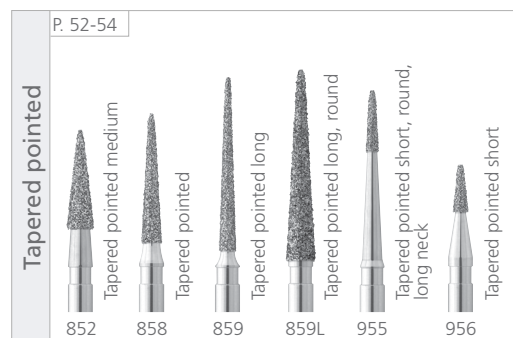
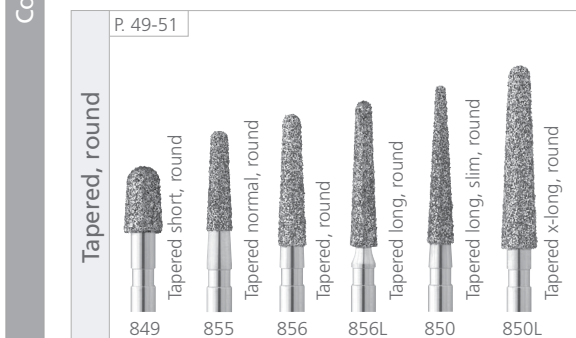
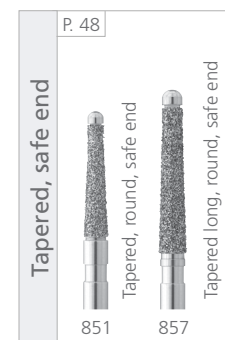
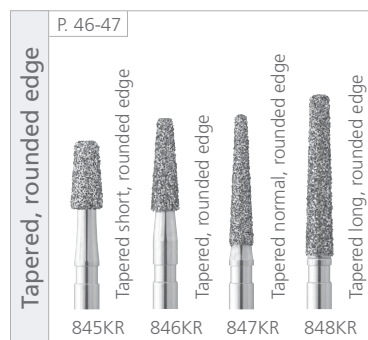
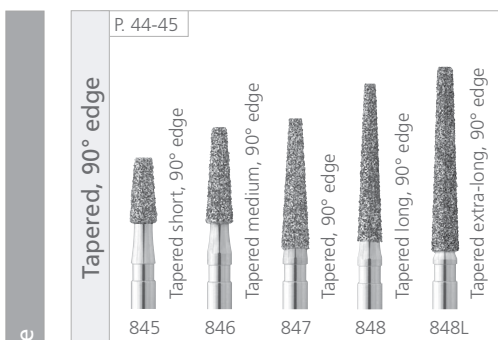
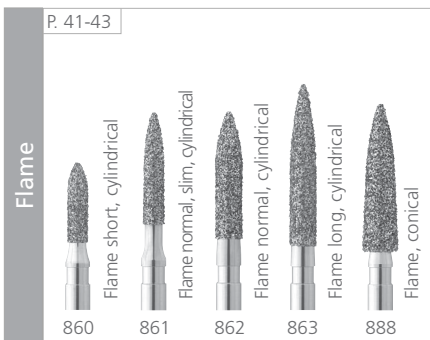
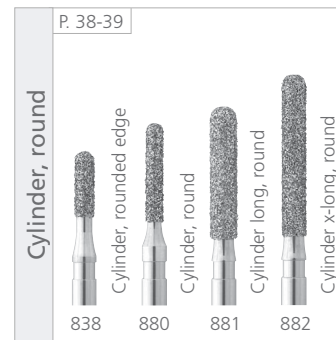
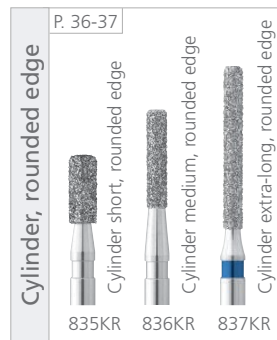
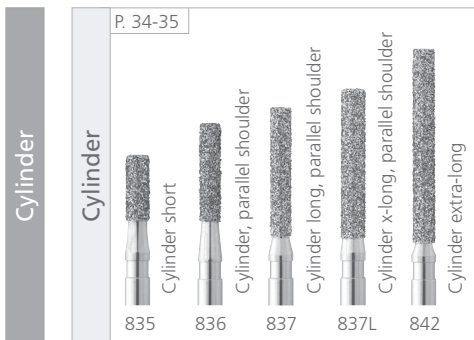
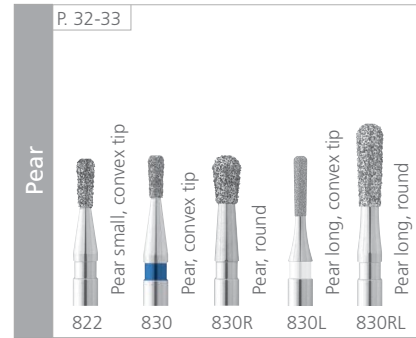
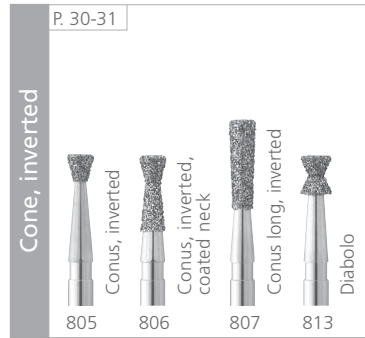
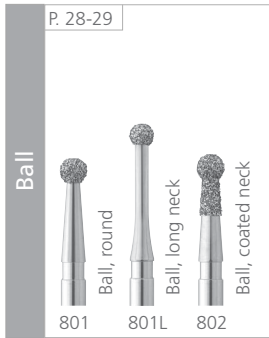

Torpedo

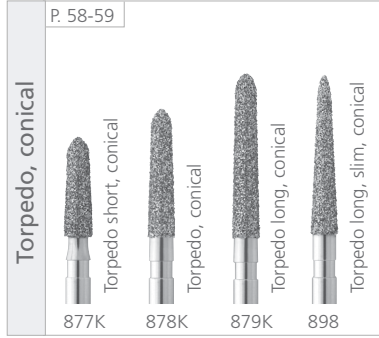
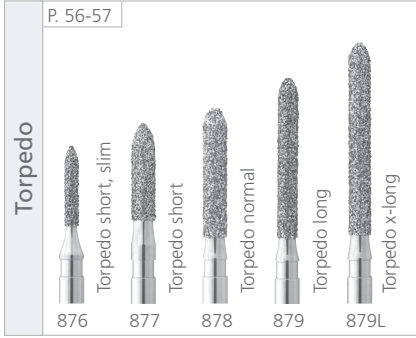

Football

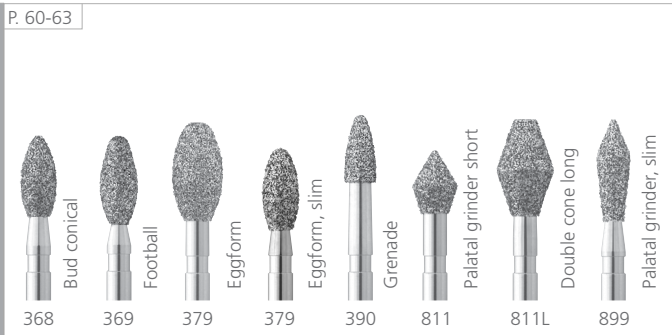

Wheel / Lenticular



Special shapes

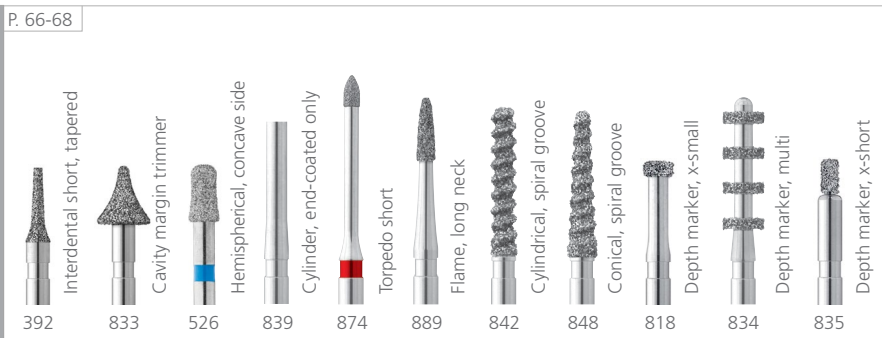

Colour code	Micron		Description
544	150 µm	125 µm	Super coarse
534	125 µm	106 µm*	Coarse
524	106 µm	60/80/90 µm*	Standard
524	80 µm		Medium
514	50 µm		Golden Burs GB
514	40 µm		Fine
514	25 µm		Fine
504	15 µm		Extra fine
494	8 µm		Ultra fine

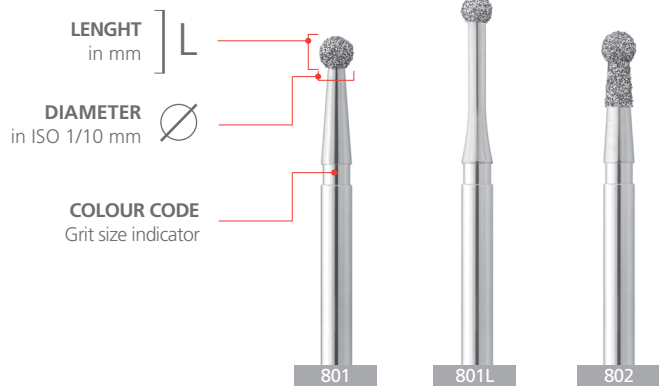

*Depending on the shape and size of the instruments, the grit size may differ from the specified value.

BALL 801 • Round



ISO 314	Ø 006	Ø 007	Ø 009	Ø 010	Ø 012	Ø 014	Ø 016	Ø 017	Ø 018
	FG 189	FG 199	FG 200S	FG 200N FG 8200S	FG 200C FG 200 FG 8200 FG 200GB FG 4201S	FG 201SC FG 201S	FG 201SCB FG 201NC FG 201N FG 201NGB	FG 4201 FG 3201 FG 5201	FG 201NCB FG 201C FG 201 FG 8201 FG 201GB
	FG 201CB	FG 400AC FG 400A FG 400SGB FG 4400S FG 3400S FG 5400S	FG 400SC FG 400S FG 8400S FG 400NGB FG 4400N FG 3400N	FG 400SCB FG 4400 FG 3400 FG 5400 FG 9400	FG 400NCB FG 400NC FG 400N FG 8400N FG 400GB	FG 400C FG 400 FG 8400	FG 400CB FG 400BC FG 400B	FG 401GB FG 4401 FG 3401 FG 5401 FG 9401	FG 401CB FG 401C FG 401

ISO 315	Ø 012	Ø 014	Ø 016	Ø 018	Ø 023	Ø 025	Ø 027
	FGL 200C FGL 200	FGL 201SC FGL 201S	FGL 201NC FGL 201N	FGL 201C FGL 201	FGL 400SC FGL 400S	FGL 400NC FGL 400N	FGL 400C FGL 400

ISO 204	Ø 007	Ø 009	Ø 012	Ø 014	Ø 017	Ø 018	Ø 021	Ø 023	Ø 024
	RA 199	RA 200S RA 200SGB	RA 200C RA 200 RA 200GB	RA 201SC RA 201S RA 201SGB	RA 4201 RA 3201 RA 5201	RA 201C RA 201 RA 201GB	RA 400SGB RA 5400S	RA 400SC RA 400S	RA 4400 RA 5400
	RA 400GB	RA 400C RA 400	RA 401GB RA 4401	RA 401C RA 401					

BALL 801L • Round, long neck



FG • ISO 314	L 7.0 ∅ 007	L 10.5 ∅ 012	L 10.5 ∅ 014	L 8.5 ∅ 015	L 8.5 ∅ 016	L 10 ∅ 016	L 10.5 ∅ 018	L 10.5 ∅ 023
	FG 4699	FG 200L	FG 196L	FG 4201NL	FG 201NLC FG 201NL FG 8201NL	FG 203LC FG 203L	FG 201L	FG 204LC FG 204L

BALL 802 • Round, coated neck



FG • ISO 314	L 2.5 ∅ 009	L 2.5 ∅ 010	L 2.5 ∅ 012	L 3.0 ∅ 014	L 3.5 ∅ 016	L 4.0 ∅ 018	L 4.0 ∅ 019	L 4.5 ∅ 023
	FG 300SC FG 300S FG 300SGB FG 4300S	FG 300A	FG 300C FG 300 FG 300GB	FG 301SC FG 301S FG 301SGB	FG 301AC FG 301A	FG 301C FG 301 FG 301GB	FG 301CB	FG 302AC FG 302A

RA • ISO 204	L 2.5 ∅ 012	L 3.0 ∅ 014	L 4.0 ∅ 018
	RA 300	RA 301S	RA 301





Intensiv PrepTwins

RA • ISO 204	∅ 020
	RA PT801/6 RA PT4801/6 RA PT5801/6

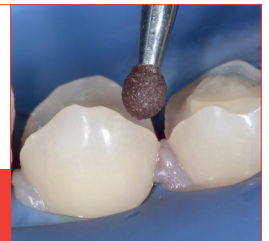
Diamond Polymer Finisher for refined shaping of all preparations.

See
pages
100-101





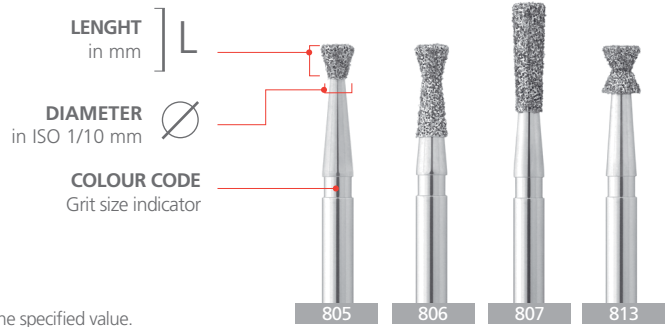















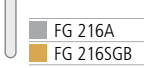
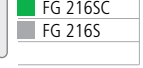
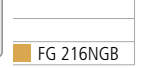
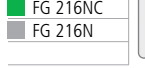
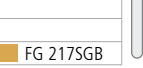
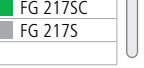
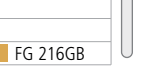
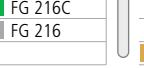
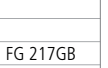





Colour code	Micron		Description
 544	150 µm	125 µm	Super coarse
 534	125 µm	106 µm*	Coarse
 524	106 µm	60/80/90 µm*	Standard
 514	50 µm		Golden Burs GB



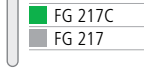
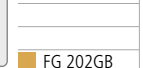
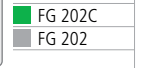

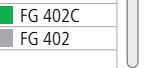

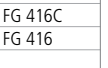

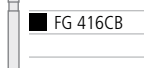
*Depending on the shape and size of the instruments, the grit size may differ from the specified value.

CONE 805 • Inverted



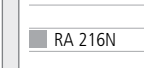
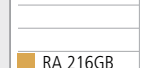
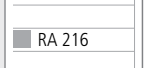

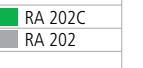









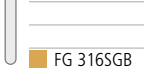
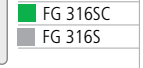
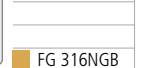
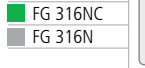

FG • ISO 314	 L 0.5 Ø 007	 L 0.5 Ø 008	 L 0.7 Ø 008	 L 0.7 Ø 009	 L 1.0 Ø 009	 L 1.0 Ø 010	 L 1.0 Ø 011	 L 1.0 Ø 012	 L 1.3 Ø 013
									
	 L 1.3 Ø 014	 L 1.5 Ø 015	 L 1.5 Ø 016	 L 1.5 Ø 017	 L 2.0 Ø 017	 L 2.0 Ø 018	 L 2.0 Ø 019	 L 2.5 Ø 022	 L 2.5 Ø 023
									
	 L 2.5 Ø 024								
									

RA • ISO 204	 L 0.7 Ø 009	 L 1.0 Ø 011	 L 1.0 Ø 012	 L 1.5 Ø 015	 L 1.5 Ø 016
					

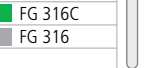
CONE 806 • Inverted, coated neck

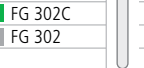

FG • ISO 314	 L 1.8 Ø 007	 L 1.8 Ø 008	 L 2.0 Ø 008	 L 2.0 Ø 009	 L 2.5 Ø 011	 L 2.5 Ø 012	 L 5.0 Ø 017	 L 5.0 Ø 018	 L 5.0 Ø 019
									

CONE 807 • Long, inverted



FG • ISO 314	 FG 207	 FG 215SGB	 FG 215SC FG 215S	 FG 215GB	 FG 215C FG 215	 FG 118	 FG 115GB	 FG 115C FG 115	 FG 115CB
	 FG 119C FG 119	 FG 119AC FG 119A							

DIABOLO 813



FG • ISO 314	 FG 297	 FG 298C FG 298	 FG 299C FG 299	 FG 303SC FG 303S	 FG 303AC FG 303A	 FG 303C FG 303	 FG 303CB

Intensiv Guided Universal Prep Set

Intensiv has developed with experts a variety of sets for specific clinical applications. Such as Intensiv Guided Universal Prep Set for the preparation methods of modern reconstructive dentistry.

See pages 14-15



Colour code	Micron		Description
544	150 µm	125 µm	Super coarse
534	125 µm	106 µm*	Coarse
524	106 µm	60/80/90 µm*	Standard
524	80 µm		Medium
514	50 µm		Golden Burs GB
514	40 µm		Fine
514	25 µm		Fine
504	15 µm		Extra fine
494	8 µm		Ultra fine

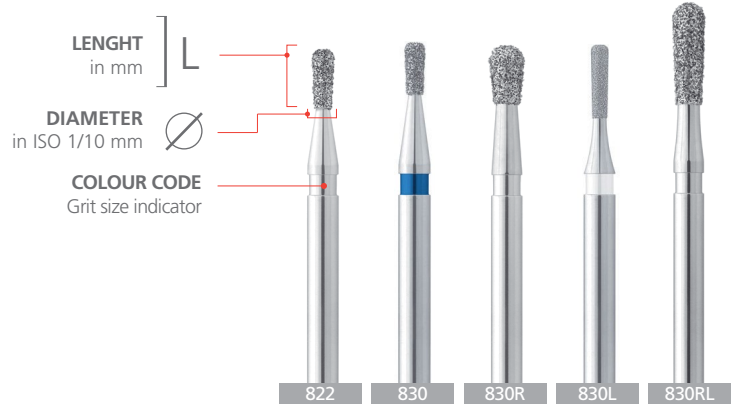

*Depending on the shape and size of the instruments, the grit size may differ from the specified value.

PEAR 822 • Small, convex tip

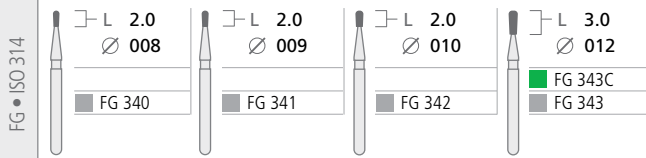

PEAR 830 • Convex tip

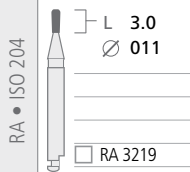
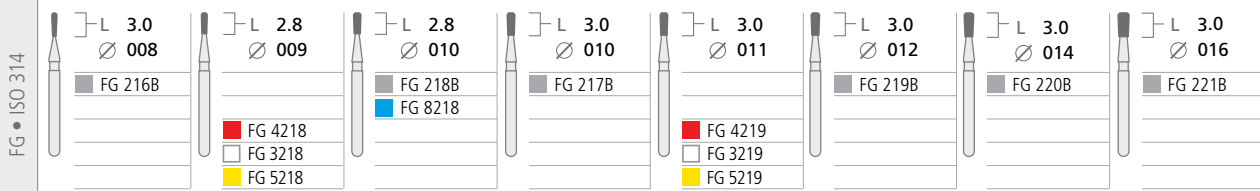

PEAR 830R • Round

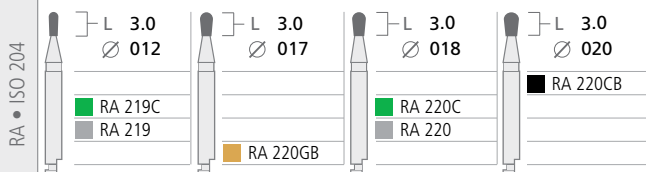
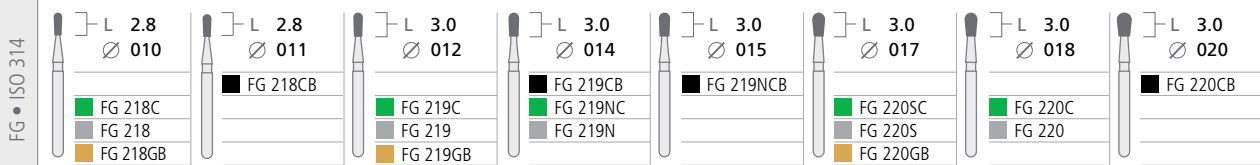

PEAR 830L • Long, convex tip



FG • ISO 314	L 3.8 ∅ 009 FG 3224	L 4.2 ∅ 010 FG 3225	L 3.8 ∅ 011 FG 8224	L 4.2 ∅ 012 FG 8225	L 4.5 ∅ 012 FG 9223	L 4.5 ∅ 013 FG 4223 FG 3223 FG 5223	L 5.0 ∅ 013 FG 9323	L 4.5 ∅ 014 FG 4223R	L 5.0 ∅ 014 FG 3323
	L 5.0 ∅ 015 FG 4323	L 4.5 ∅ 015 FG 223B FG 8223	L 5.0 ∅ 016 FG 229C FG 229	L 5.0 ∅ 018 FG 230C FG 230					

RA • ISO 204	L 4.5 ∅ 013 RA 4223 RA 3223 RA 5223	L 4.5 ∅ 014 RA 4223R							
--------------	---	----------------------------	--	--	--	--	--	--	--

PEAR 830RL • Long, round



FG • ISO 314	L 3.8 ∅ 009 FG 224GB FG 4224	L 3.8 ∅ 010 FG 224C FG 224	L 4.2 ∅ 010 FG 5225	L 4.2 ∅ 011 FG 225GB FG 4225	L 4.2 ∅ 012 FG 225C FG 225	L 4.2 ∅ 013 FG 225CB	L 4.5 ∅ 013 FG 223GB	L 4.5 ∅ 014 FG 223C FG 223	L 4.5 ∅ 015 FG 223CB
	L 5.0 ∅ 016 FG 226C FG 226	L 5.0 ∅ 018 FG 227C FG 227	L 5.0 ∅ 019 FG 227CB						

RA • ISO 204	L 4.2 ∅ 011 RA 225GB	L 4.5 ∅ 013 RA 223GB	L 4.5 ∅ 014 RA 223						
--------------	----------------------------	----------------------------	--------------------------	--	--	--	--	--	--

Colour code	Micron		Description
544	150 µm	125 µm	Super coarse
534	125 µm	106 µm*	Coarse
524	106 µm	60/80/90 µm*	Standard
524	80 µm		Medium
514	50 µm		Golden Burs GB
514	40 µm		Fine
514	25 µm		Fine
504	15 µm		Extra fine
494	8 µm		Ultra fine

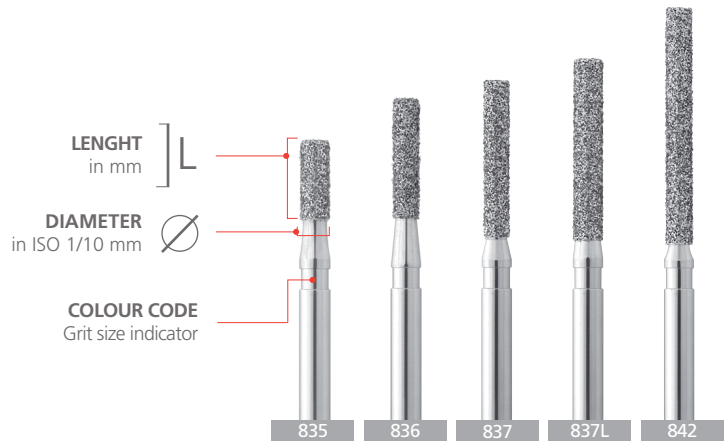

*Depending on the shape and size of the instruments, the grit size may differ from the specified value.

CYLINDER 835 • Short



FG • ISO 314	L 2.0 ∅ 007	L 3.0 ∅ 007	L 3.0 ∅ 007	L 4.0 ∅ 007	L 3.0 ∅ 008	L 4.0 ∅ 008	L 3.0 ∅ 009	L 4.0 ∅ 009	L 3.0 ∅ 010	
	FG 4612	FG 4211S FG 3211S	FG 3212S	FG 612	FG 211S FG 212SGB FG 4212S FG 3210	FG 212GB FG 4212	FG 212S FG 8212S FG 210GB FG 4210	FG 212C FG 212	FG 212SCB FG 210C FG 210	
	FG 212CB FG 211C FG 211 FG 8211	FG 210CB	FG 214C FG 214 FG 8214	FG 214CB	FG 204C FG 204 FG 8204	FG 204CB	FG 244C FG 244	FG 244CB		
	FG 3214 FG 5214		FG 214GB FG 4214		FG 204GB FG 4204			FG 9214		
	L 4.0 ∅ 018	L 4.0 ∅ 021	L 4.0 ∅ 022	L 4.0 ∅ 023						
	FG 244AC FG 244A		FG 304C FG 304	FG 304CB						
		FG 304GB FG 4304								
RA • ISO 204	L 3.0 ∅ 009	L 4.0 ∅ 009	L 3.0 ∅ 010	L 4.0 ∅ 012	L 4.0 ∅ 013	L 4.0 ∅ 014				
	RA 212S RA 210GB	RA 212	RA 210	RA 214C RA 214		RA 204GB	RA 204C RA 204			

CYLINDER 836 • Parallel shoulder



ISO 314	ISO 314	ISO 314	ISO 314	ISO 314	ISO 314	ISO 204	ISO 204
L 6.0 ∅ 008	L 6.0 ∅ 010	L 6.0 ∅ 013	L 6.0 ∅ 015	L 6.0 ∅ 016	L 6.0 ∅ 018	L 6.0 ∅ 013	L 6.0 ∅ 015
FG 98	FG 99	FG 114SC FG 114S FG 114GB FG 4114	FG 114CB FG 114C FG 114	FG 114AC FG 114A	FG 115AC FG 115A	RA 114GB	RA 114

CYLINDER 837 • Long, parallel shoulder



ISO 314	ISO 314	ISO 314	ISO 314	ISO 314	ISO 314	ISO 314	ISO 314	ISO 314	ISO 314
L 8.0 ∅ 010	L 8.0 ∅ 010	L 8.0 ∅ 011	L 8.0 ∅ 012	L 8.0 ∅ 013	L 8.0 ∅ 014	L 8.0 ∅ 015	L 8.0 ∅ 016	L 8.0 ∅ 018	L 8.0 ∅ 018
FG 314A	FG 4036 FG 5314S	FG 314SGB FG 4314S	FG 314SC FG 314S	FG 314SCB FG 314GB FG 4314	FG 314C FG 314	FG 314CB	FG 315AC FG 315A	FG 313AC FG 313A	

ISO 204	ISO 204	ISO 204	ISO 204	ISO 204
L 8.0 ∅ 010	L 8.0 ∅ 011	L 8.0 ∅ 012	L 8.0 ∅ 013	L 8.0 ∅ 014
RA 4036	RA 314SGB	RA 314S	RA 314GB	RA 314C RA 314

CYLINDER 837L • X-long, parallel shoulder









ISO 314	ISO 314	ISO 314	ISO 314	ISO 314	ISO 314	ISO 314	ISO 314	ISO 314
L 9.0 ∅ 010	L 9.0 ∅ 012	L 9.0 ∅ 014	L 9.0 ∅ 015	L 9.0 ∅ 016	L 9.0 ∅ 017	L 9.0 ∅ 018	L 9.0 ∅ 019	L 9.0 ∅ 019
FG 312L	FG 313LC FG 313L	FG 316LC FG 316L FG 4314L	FG 314LGB	FG 314LC FG 314L	FG 314LCB FG 317LGB	FG 317LC FG 317L	FG 317LCB	

CYLINDER 842 • Extra-long



ISO 314
L 12.0 ∅ 014
FG 502C FG 502



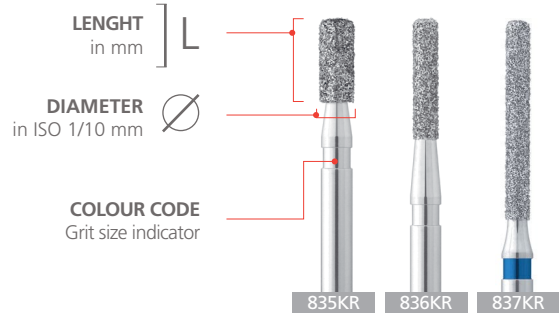













Colour code	Micron		Description
 534	125 µm	106 µm*	Coarse
 524	106 µm	60/80/90 µm*	Standard
 524	80 µm		Medium
 514	40 µm		Fine
 514	25 µm		Fine
 504	15 µm		Extra fine
 494	8 µm		Ultra fine



*Depending on the shape and size of the instruments, the grit size may differ from the specified value.

























CYLINDER 835KR • Short, rounded edge



FG • ISO 314	 L 4.0 ∅ 008	 L 4.0 ∅ 010	 L 4.0 ∅ 012	 L 4.0 ∅ 014	 L 4.0 ∅ 016	 L 4.0 ∅ 018	
	 FG 261	 FG 262	 FG 263C  FG 263	 FG 264C  FG 264	 FG 265C  FG 265	 FG 266C  FG 266	

CYLINDER 836KR • Medium, rounded edge



FG • ISO 314	 L 6.0 ∅ 008	 L 6.0 ∅ 009	 L 5.0 ∅ 010	 L 6.0 ∅ 010	 L 6.0 ∅ 011	 L 6.0 ∅ 011	 L 6.0 ∅ 011	 L 6.0 ∅ 012	 L 6.0 ∅ 013
	 FG 397		 FG 8710	 FG 398	 FG 8510	 FG 3414  FG 5414	 FG 3514  FG 5514	 FG 399C  FG 399	 FG 4414
		 FG 3510  FG 5510	 FG 3710B					 FG 3414B	

CYLINDER 837KR • Extra-long, rounded edge











FG • ISO 314	 L 8.0 Ø 009 FG 3712B FG 5712B	 L 8.0 Ø 010 FG 609C FG 609	 L 8.0 Ø 011 FG 712C FG 8712	 L 8.0 Ø 012 FG 3614	 L 8.0 Ø 013 FG 4614	 L 8.0 Ø 014 FG 611C FG 8614 FG 3614B	 L 8.0 Ø 016 FG 4614B	 L 10.0 Ø 012 FG 4305LP	 L 10.0 Ø 013 FG 305LPC FG 8305LP FG 5325L
	 L 10.0 Ø 014 FG 4325L	 L 10.0 Ø 015 FG 8325L	 L 10.0 Ø 016 FG 326C FG 326 FG 9327	 L 10.0 Ø 018 FG 327C FG 327					

Intensiv Combi Prep Set: Direct Restoration

Intensiv has developed with experts a variety of sets for specific clinical applications. Such as Intensiv Combi Prep Set: Direct Restoration for direct tooth-coloured adhesive restorations.

See
page 10





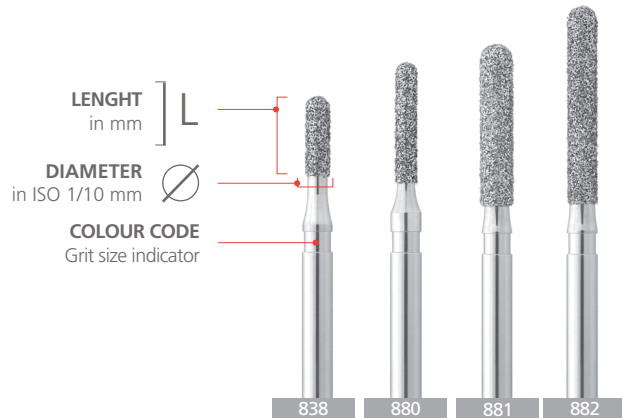









Colour code	Micron		Description
 544	150 µm	125 µm	Super coarse
 534	125 µm	106 µm*	Coarse
 524	106 µm	60/80/90 µm*	Standard
 524	80 µm		Medium
 514	50 µm		Golden Burs GB
 514	40 µm		Fine
 514	25 µm		Fine
 504	15 µm		Extra fine
 494	8 µm		Ultra fine



*Depending on the shape and size of the instruments, the grit size may differ from the specified value.

CYLINDER 838 • Rounded edge



















FG • ISO 314	L 4.0 ∅ 008	L 4.0 ∅ 009	L 4.0 ∅ 010	L 4.0 ∅ 012	L 4.0 ∅ 013	L 4.0 ∅ 014	L 4.0 ∅ 015
 FG 412A	 FG 412C	 FG 412	 FG 411	 FG 411AC	 FG 411A	 FG 404C	 FG 404CB
 FG 412GB					 FG 404GB	 FG 8404	
					 FG 3404		

RA • ISO 204	L 4.0 ∅ 014
 RA 404	

CYLINDER 880 • Round



FG • ISO 314	L 6.0 ∅ 009	L 6.0 ∅ 010	L 6.0 ∅ 011	L 6.0 ∅ 012	L 6.0 ∅ 013	L 6.0 ∅ 014	L 6.0 ∅ 016
 FG 305SGB	 FG 305SC	 FG 305S	 FG 305SCB	 FG 305C	 FG 305	 FG 305CB	 FG 334C
 FG 4305S	 FG 3305	 FG 5305	 FG 305GB	 FG 4305			 FG 336C
						 FG 334	 FG 336

CYLINDER 881 • Long, round



FG • ISO 314	L 8.0 ∅ 009	L 8.0 ∅ 010	L 8.0 ∅ 011	L 8.0 ∅ 012	L 8.0 ∅ 013	L 8.0 ∅ 014	L 8.0 ∅ 014	L 8.0 ∅ 015	L 8.0 ∅ 016
	FG 309GB	FG 309C FG 309	FG 309CB FG 321C FG 321	FG 322C FG 322	FG 315SGB FG 4315S	FG 315SC FG 315S FG 8315S	FG 324C FG 324	FG 315SCB	FG 307C FG 307
			FG 4322	FG 3315S FG 5315S				FG 307GB FG 4307	FG 5315

RA • ISO 204	L 8.0 ∅ 013	L 8.0 ∅ 014	L 8.0 ∅ 016	L 8.0 ∅ 017	L 8.0 ∅ 018	L 8.0 ∅ 019	L 8.0 ∅ 019	L 8.0 ∅ 020	L 9.0 ∅ 020	L 8.0 ∅ 021	L 9.0 ∅ 021
	RA 315SGB	RA 315SC RA 315S	FG 307CB	FG 325C FG 325	FG 325CB	FG 315GB FG 4315	FG 315LGB FG 4315L	FG 315C FG 315	FG 315LC FG 315L FG 8315L	FG 315CB	FG 315LCB
			FG 3315L FG 5315L FG 9315L	FG 325GB FG 4325							

CYLINDER 882 • X-long, round



FG • ISO 314	L 10.0 ∅ 010	L 10.0 ∅ 011	L 10.0 ∅ 011	L 10.0 ∅ 012	L 10.0 ∅ 013	L 10.0 ∅ 014	L 10.0 ∅ 015	L 10.0 ∅ 016	L 10.0 ∅ 017	
	FG 3305L FG 5305L FG 9305L	FG 307AC FG 307A	FG 305LC FG 305L FG 8305L	FG 305LCB	FG 307NGB FG 4307N	FG 307NC FG 307N	FG 307NCB	FG 307LGB FG 4307L	FG 307LC FG 307L	FG 307LCB
		FG 305LGB FG 4305L	FG 4038							

RA • ISO 204	L 10.0 ∅ 011	L 10.0 ∅ 011	L 10.0 ∅ 012
	RA 4038	RA 305LGB	RA 305L

Colour code	Micron		Description
544	150 µm	125 µm	Super coarse
534	125 µm	106 µm*	Coarse
524	106 µm	60/80/90 µm*	Standard
524	80 µm		Medium
514	50 µm		Golden Burs GB
514	40 µm		Fine
514	25 µm		Fine
504	15 µm		Extra fine
494	8 µm		Ultra fine

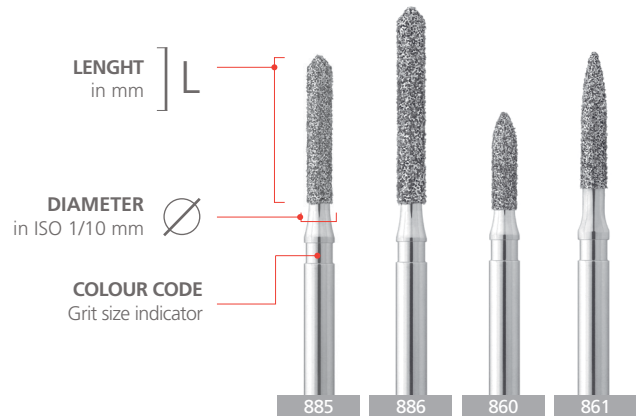

*Depending on the shape and size of the instruments, the grit size may differ from the specified value.

CYLINDER 885 • Pointed

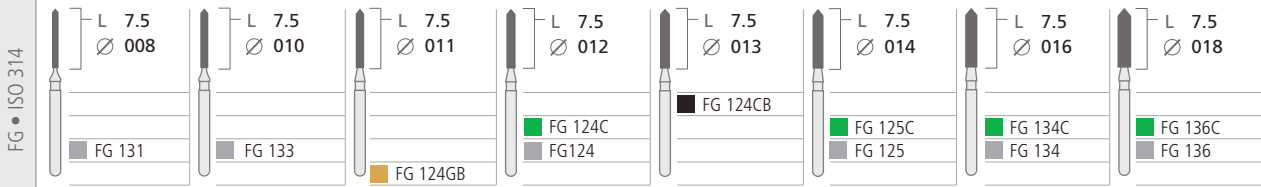
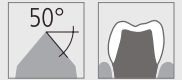

CYLINDER 886 • Long, pointed

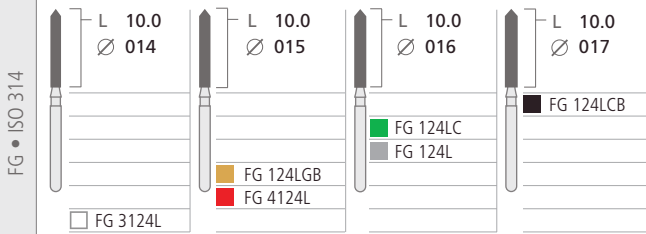
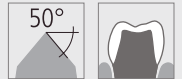

Intensiv PrepTwins

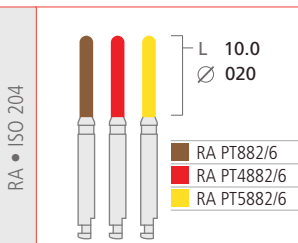

Diamond Polymer Finisher for refined shaping of all preparations.

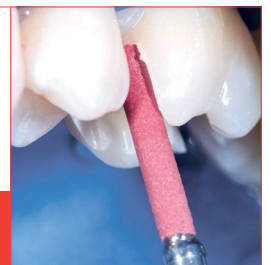

See pages 100-101

FLAME 860 • Short, cylindrical



FG • ISO 314	 FG D40	 FG 2055	 FG 2055C FG 2055 FG 4205 FG 3205 FG 5205	 FG 205GB	 FG 205C FG 205	 FG 205CB	 FG 269C FG 269

RA • ISO204	 RA 9205	 RA 4205 RA 3205 RA 5205	 RA 205GB	 RA 205

FLAME 861 • Normal, slim, cylindrical



FG • ISO 314	 FG 9205L	 FG 4205L FG 3205L FG 5205L	 FG 205LGB	 FG 205LC FG 205L	 FG 205LCB	 FG 285LC FG 285L	 FG 285LCB

RA • ISO 204	 RA 4205L RA 5205L	 RA 205LGB	 RA 205L

Colour code	Micron		Description
544	150 µm	125 µm	Super coarse
534	125 µm	106 µm*	Coarse
524	106 µm	60/80/90 µm*	Standard
524	80 µm		Medium
514	50 µm		Golden Burs GB
514	40 µm		Fine
514	25 µm		Fine
504	15 µm		Extra fine

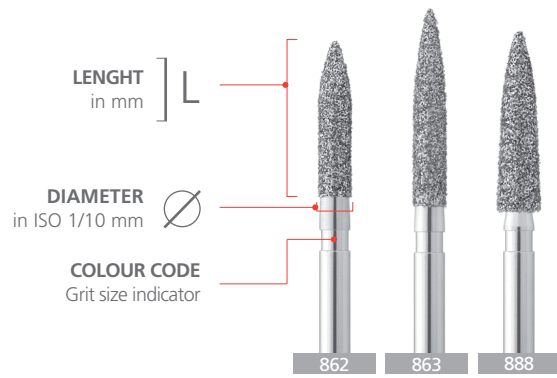

*Depending on the shape and size of the instruments, the grit size may differ from the specified value.

FLAME 862 • Normal, cylindrical



Category	Length (L)	Diameter (∅)	Color	Product Code
FG • ISO 314	8.0	009	Grey	FG 363
	8.0	010	Green	FG 364C
	8.0	010	Grey	FG 364
	8.0	011	Red	FG 4365
	8.0	012	Green	FG 365C
	8.0	012	Grey	FG 365
	8.0	013	Red	FG 4311S
	8.0	014	Green	FG 311SC
	8.0	014	Grey	FG 311S
	8.0	015	Yellow	FG 311GB
	8.0	015	Red	FG 4311
	8.0	016	Green	FG 311C
	8.0	016	Grey	FG 311
	8.0	017	Black	FG 311CB
	8.0	017	Yellow	FG 312GB
FG • ISO 314	8.0	018	Green	FG 312C
	8.0	018	Grey	FG 312
	8.0	019	Black	FG 312CB
	8.0	021	Green	FG 367C
	8.0	021	Grey	FG 367
	8.0	021	Black	FG 312CB
RA • ISO 204	8.0	015	Yellow	RA 311GB
	8.0	015	Red	RA 4311
	8.0	016	Grey	RA 311
	8.0	016	Grey	RA 311

Intensiv PrepTwins

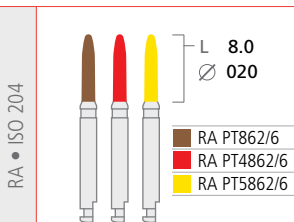

Diamond Polymer Finisher for refined shaping of all preparations.



See pages 100-101

FLAME 863 • Long, cylindrical



FG • ISO 314	L 10.0 Ø 009 FG 9405L	L 10.0 Ø 010 FG 404L FG 3405L FG 5405L	L 10.0 Ø 011 FG 405LGB FG 4405L	L 10.0 Ø 012 FG 405LC FG 405L FG 5505	L 10.0 Ø 013 FG 505GB FG 4505 FG 9505L	L 10.0 Ø 014 FG 505C FG 505 FG 5505L	L 10.0 Ø 015 FG 505LGB FG 4505L	L 10.0 Ø 016 FG 505LC FG 505L FG 8505L FG 5312N	L 10.0 Ø 017 FG 312NGB FG 4312N
	L 10.0 Ø 018 FG 312NC FG 312N	L 10.0 Ø 019 FG 312NCB	L 10.0 Ø 021 FG 378C FG 378						

RA • ISO 204	L 10.0 Ø 011 RA 405LGB	L 10.0 Ø 012 RA 405L						
--------------	------------------------------	----------------------------	--	--	--	--	--	--

FLAME 888 • Conical



FG • ISO 314	L 6.5 Ø 018 FG 95GB	L 6.5 Ø 019 FG 95C FG 95	L 9.0 Ø 022 FG D20GB	L 11.0 Ø 022 FG D21GB FG 40D21	L 9.0 Ø 023 FG D20C FG D20	L 11.0 Ø 023 FG D21C FG D21	L 9.0 Ø 024 FG D20CB	L 11.0 Ø 024 FG D21CB
--------------	---------------------------	-----------------------------------	----------------------------	---	-------------------------------------	--------------------------------------	----------------------------	-----------------------------

RA • ISO 204	L 6.5 Ø 018 RA 95GB	L 6.5 Ø 019 RA 95C RA 95	L 11.0 Ø 022 RA D21GB	L 9.0 Ø 023 RA D20	L 11.0 Ø 023 RA D21			
--------------	---------------------------	-----------------------------------	-----------------------------	--------------------------	---------------------------	--	--	--

TAPERED 847 • 90° edge



FG • ISO 314	L 8.0 ∅ 010	L 8.0 ∅ 012	L 8.0 ∅ 014	L 8.0 ∅ 015	L 8.0 ∅ 016	L 8.0 ∅ 017	L 8.0 ∅ 018	L 8.0 ∅ 022	L 8.0 ∅ 023
	FG 116A FG 116GB FG 3116	FG 116C FG 116	FG 116CB FG 116NC FG 116N	FG 117GB FG 4117	FG 117C FG 117 FG 8117	FG 117CB FG 117NGB FG 4117N	FG 117NC FG 117N	FG 113NGB FG 4520	FG 520
FG • ISO 314	L 8.0 ∅ 024	L 8.0 ∅ 025	L 8.0 ∅ 028	L 8.0 ∅ 029	L 8.0 ∅ 030	RA • ISO 204			
	FG 113NC FG 113N	FG 113NCB	FG 113SGB FG 4113S FG 3113S	FG 113S FG 8113S	FG 113SCB FG 113SC	RA 117GB RA 4117	RA 117C RA 117	RA 3117 RA 5117	

TAPERED 848 • Long, 90° edge



FG • ISO 314	L 10.0 ∅ 010	L 10.0 ∅ 012	L 10.0 ∅ 013	L 10.0 ∅ 014	L 10.0 ∅ 015	L 10.0 ∅ 016	L 10.0 ∅ 017	L 10.0 ∅ 018	L 10.0 ∅ 022	
	FG D12	FG D13C FG D13	FG 50D5	FG D15C FG D15 FG 40D5	FG D5GB	FG D5C FG D5	FG D5CB	FG D19C FG D19	FG D22GB	
FG • ISO 314	L 10.0 ∅ 023	L 10.0 ∅ 024	RA • ISO 204				L 10.0 ∅ 015	L 10.0 ∅ 016	L 10.0 ∅ 023	L 10.0 ∅ 024
	FG D22C FG D22	FG D22CB	RA D5GB	RA D5	RA D22C RA D22	RA D22CB				

TAPERED 848L • Extra-long, 90° edge



FG • ISO 314	L 11.5 ∅ 012	L 11.5 ∅ 014	L 11.5 ∅ 016	L 11.5 ∅ 018	L 11.5 ∅ 021
	FG D13LC FG D13L	FG D15LC FG D15L	FG D5LC FG D5L	FG D19LC FG D19L	FG D22LC FG D22L

Colour code	Micron		Description
544	150 µm	125 µm	Super coarse
534	125 µm	106 µm*	Coarse
524	106 µm	60/80/90 µm*	Standard
524	80 µm		Medium
514	50 µm		Golden Burs GB
514	40 µm		Fine
514	25 µm		Fine
504	15 µm		Extra fine
494	8 µm		Ultra fine

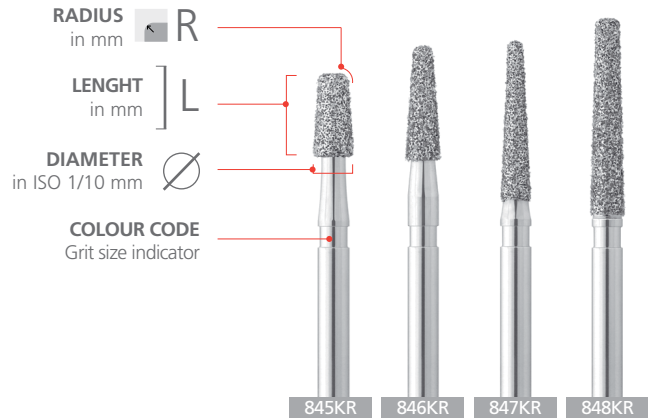

*Depending on the shape and size of the instruments, the grit size may differ from the specified value.

KONUS 845KR • Short, rounded edge



FG • ISO 314	Length L 4.0, Diameter ∅ 014	Length L 4.0, Diameter ∅ 015	Length L 4.0, Diameter ∅ 016	Length L 4.0, Diameter ∅ 017	Length L 4.0, Diameter ∅ 018	Length L 4.0, Diameter ∅ 020	Length L 4.0, Diameter ∅ 021	Length L 4.0, Diameter ∅ 022	Length L 4.0, Diameter ∅ 023
FG 5407R	FG 407RC FG 407R	FG 407RC FG 407R	FG 407RC FG 407R	FG 409RC FG 409R	FG 409RC FG 409R	FG 411RC FG 411R	FG 411RC FG 411R	FG 413RC FG 413R	FG 413RC FG 413R
	FG 407RGB FG 4407R		FG 409RGB FG 4409R		FG 411RGB FG 3413R		FG 413RGB FG 4413R		
		FG 3409R							

TAPERED 846KR • Rounded edge



FG • ISO 314	R 0.28, L 6.0, ∅ 012	R 0.28, L 6.0, ∅ 014	R 0.20, L 6.0, ∅ 014	R 0.28, L 6.0, ∅ 014	R 0.20, L 6.0, ∅ 015	R 0.28, L 6.0, ∅ 015	R 0.20, L 6.0, ∅ 016	R 0.20, L 6.0, ∅ 016	R 0.20, L 6.0, ∅ 017
FG 1040				FG 8425	FG 4417R	FG 425CB	FG 417RC FG 417R FG 8417R		FG 3113R
		FG 3425	FG 5417R					FG 3513	
FG • ISO 314	R 0.20, L 6.0, ∅ 018	R 0.28, L 6.0, ∅ 018	R 0.16, L 6.0, ∅ 019	RA • ISO 204, R 0.16, L 6.0, ∅ 017					
FG 513C FG 513 FG 8513		FG 8525	FG 8113R	RA 3113R					
		FG 3525							

TAPERED 847KR • Normal, rounded edge



FG • ISO 314	 FG 4427 FG 3427 FG 5422R	 FG 8427 FG 3422R	 FG 422RCB FG 422RC FG 422R FG 8422R FG 4422R	 FG 517C FG 517 FG 8517 FG 4517 FG 3517	 FG 526GB FG 5526	 FG 526C FG 526 FG 8526	 FG 4526 FG 3526
	 FG 3113NR FG 4113NR FG 3513N	 FG 113NR FG 8113NR	 FG 113NR FG 8113NR				



TAPERED 848KR • Long, rounded edge



FG • ISO 314	 FG 5423R	 FG 423RGB	 FG 423RC FG 423R FG 8423R	 FG 423RCB

Intensiv PrepTwins

RA • ISO 204		Diamond Polymer Finisher for refined shaping of all preparations.	
	RA PT847KR/6 RA PT4847KR/6 RA PT5847KR/6	<p style="background-color: red; color: white; padding: 5px; display: inline-block;">See pages 100-101</p>	

Colour code	Micron		Description
 534	125 µm	106 µm*	Coarse
 524	106 µm	60/80/90 µm*	Standard
 514	50 µm		Golden Burs GB

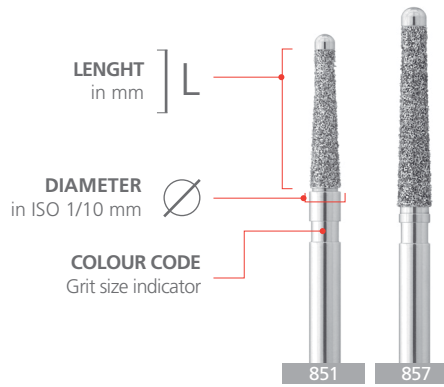

*Depending on the shape and size of the instruments, the grit size may differ from the specified value.

TAPERED 851 • Round, safe end



FG • ISO 314

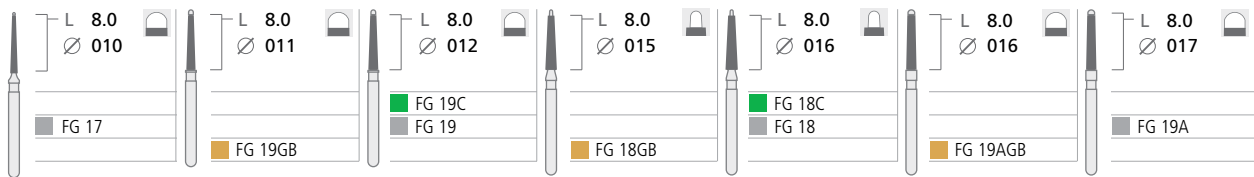

RA • ISO 204

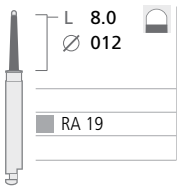

TAPERED 857 • Long, round, safe end



FG • ISO 314

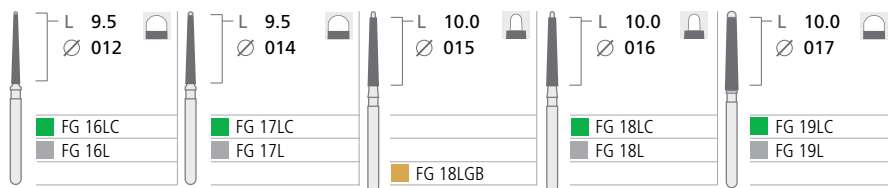

RA • ISO 204

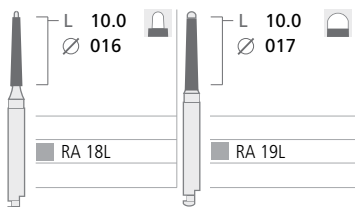

Colour code	Micron		Description
544	150 µm	125 µm	Super coarse
534	125 µm	106 µm*	Coarse
524	106 µm	60/80/90 µm*	Standard
524	80 µm		Medium
514	50 µm		Golden Burs GB
514	40 µm		Fine
514	25 µm		Fine
504	15 µm		Extra fine

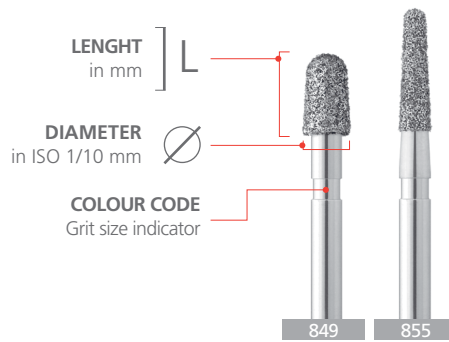

*Depending on the shape and size of the instruments, the grit size may differ from the specified value.

TAPERED 849 • Short, round



FG • ISO 314

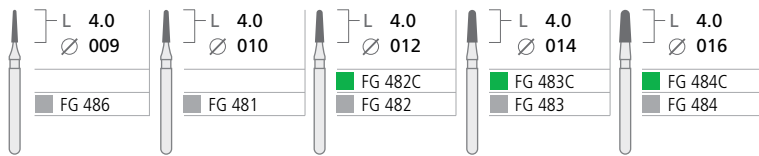

TAPERED 855 • Normal, round



FG • ISO 314

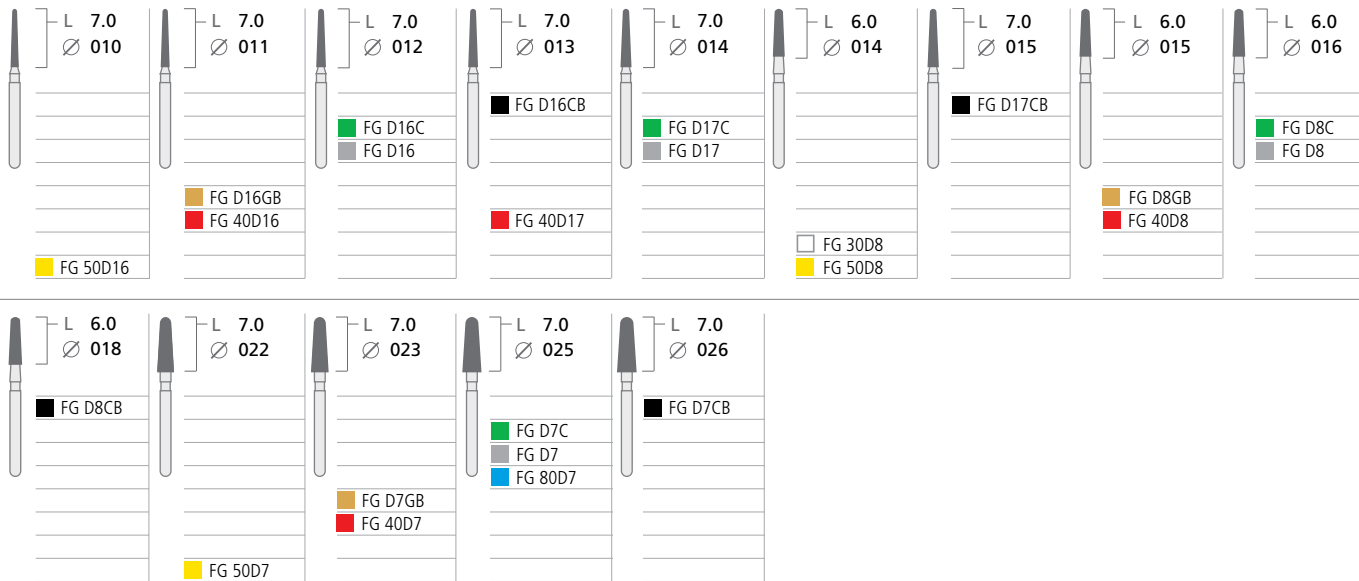

RA • ISO 204

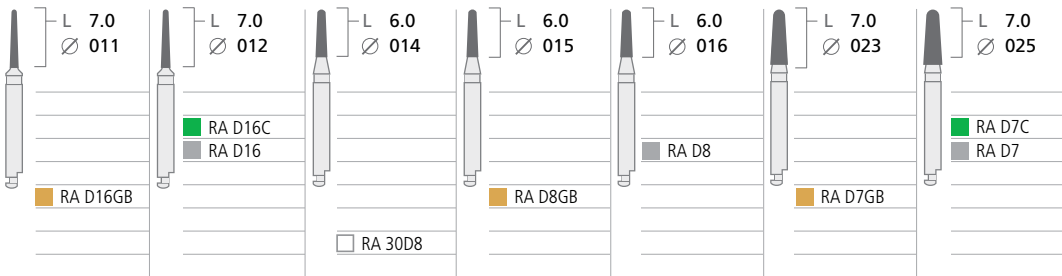

TAPERED 850 • Long, slim, round











FG • ISO 314	L 10.0 ∅ 010 FG 232 FG 233C FG 233 FG 233GB FG 4233 FG 3233	L 10.0 ∅ 011 FG 233GB FG 4233	L 10.0 ∅ 012 FG 233C FG 233	L 10.0 ∅ 013 FG 233CB FG 5234 FG 90D6	L 10.0 ∅ 014 FG 30D6 FG 50D6	L 10.5 ∅ 014 FG 231	L 10.0 ∅ 015 FG 234GB FG 234GB	L 10.0 ∅ 015 FG D6GB FG 40D6	L 10.0 ∅ 015 FG 9236
	L 10.0 ∅ 016 FG 234C FG 234 FG 8234 FG 4236 FG 3236 FG 5236	L 10.0 ∅ 016 FG 4236 FG 3236 FG 5236	L 10.0 ∅ 016 FG D6C FG D6 FG 80D6	L 10.0 ∅ 017 FG 234CB FG 234CB	L 10.0 ∅ 017 FG D6CB FG D6CB	L 10.0 ∅ 017 FG 236GB	L 10.0 ∅ 018 FG 236C FG 236 FG 8236	L 10.0 ∅ 019 FG 236CB FG 236CB	L 10.0 ∅ 020 FG 3237 FG 5237
	L 10.0 ∅ 021 FG 237GB FG 4237	L 10.0 ∅ 022 FG 237C FG 237 FG 8237	L 10.0 ∅ 023 FG 237CB FG 237CB	L 10.0 ∅ 024 FG 5238	L 10.0 ∅ 025 FG 238GB FG 4238	L 10.0 ∅ 026 FG 238C FG 238 FG 8238	L 10.0 ∅ 027 FG 238CB FG 238CB		

RA • ISO 204	L 10.0 ∅ 014 RA 50D6	L 10.0 ∅ 015 RA D6GB RA 40D6	L 10.0 ∅ 016 RA 4236 RA 3236 RA 5236	L 10.0 ∅ 016 RA D6C RA D6	L 10.0 ∅ 017 RA D6CB RA D6CB	L 10.0 ∅ 017 RA 236GB	L 10.0 ∅ 018 RA 236C RA 236
--------------	----------------------------	---------------------------------------	--	------------------------------------	---------------------------------------	-----------------------------	--------------------------------------

TAPERED 850L • X-long, round



FG • ISO 314	L 11.5 ∅ 012 FG 246C FG 246 FG 247GB	L 11.5 ∅ 014 FG 247C FG 247	L 11.5 ∅ 016 FG 248C FG 248 FG 4249	L 11.5 ∅ 018 FG 249C FG 249	L 11.0 ∅ 021 FG 3240	L 11.0 ∅ 022 FG 240GB FG 4240	L 11.0 ∅ 023 FG 240C FG 240	L 11.0 ∅ 024 FG 240CB
--------------	--	--------------------------------------	---	--------------------------------------	----------------------------	--	--------------------------------------	-----------------------------



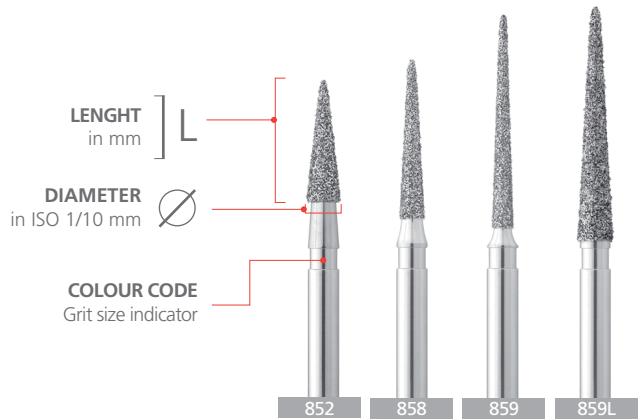











Colour code	Micron		Description
 544	150 µm	125 µm	Super coarse
 534	125 µm	106 µm*	Coarse
 524	106 µm	60/80/90 µm*	Standard
 524	80 µm		Medium
 514	50 µm		Golden Burs GB
 514	40 µm		Fine
 514	25 µm		Fine
 504	15 µm		Extra fine
 494	8 µm		Ultra fine









*Depending on the shape and size of the instruments, the grit size may differ from the specified value.

TAPERED 852 • Pointed medium

































FG • ISO 314	L 6.0 ∅ 013	L 6.0 ∅ 014	L 6.0 ∅ 015	L 6.0 ∅ 016	L 6.0 ∅ 017	L 6.0 ∅ 018	L 6.0 ∅ 019
 FG 117AC				 FG 117SC	 FG 117SCB	 FG 113AC	 FG 113ACB
 FG 117A				 FG 117S		 FG 113A	
 FG 4117A			 FG 117SGB		 FG 113AGB		
 FG 5117S			 FG 4117S				
			 FG 5113A				

RA • ISO 204	L 6.0 ∅ 014	L 6.0 ∅ 015	L 6.0 ∅ 016	L 6.0 ∅ 017	L 6.0 ∅ 018
 RA 117SGB				 RA 113AGB	 RA 113A
 RA 4117S			 RA 117S		
 RA 5117S					

TAPERED 858 • Pointed



FG • ISO 314	L 7.0 ∅ 010	L 7.0 ∅ 010	L 7.0 ∅ 011	L 7.0 ∅ 012	L 8.0 ∅ 011	L 8.0 ∅ 012	L 8.0 ∅ 013	L 8.0 ∅ 014	L 8.0 ∅ 016
 FG D11C				 FG D2C		 FG D11AC		 FG D14C	 FG 360C
 FG D11				 FG D2		 FG D11A		 FG D14	 FG 360
 FG D11GB			 FG D2GB				 FG D14GB		
 FG 30D2			 FG 40D2			 FG 30D14		 FG 40D14	
 FG 50D2						 FG 50D14			
 FG 90D2					 FG 90D14				
 FG 361C				 RA D2C				 RA D14	
 FG 361				 RA D2					
			 RA D2GB						
			 RA 40D2						
		 RA 50D2							
					 RA 90D14				

TAPERED 859 • Pointed long











FG • ISO 314	 FG D4A	 FG 90D3	 FG D4AC FG D34AGB	 FG 40D3 FG 30D3 FG 50D3	 FG 50D34	 FG D34AC FG D34A	 FG D3C FG D3 FG 80D3 FG D3GB	 FG D34GB FG 40D34 FG 30D34 FG 90D4	 FG D34C FG D34 FG 30D4 FG 50D4
	 FG D4GB FG 40D4	 FG D4C FG D4 FG 80D4	 FG D38C FG D38	 FG D39C FG D39					

RA • ISO 204	 RA 40D3 RA 50D3	 RA D3C RA D3 RA D3GB	 RA D4GB RA 40D4	 RA D4C RA D4				
--------------	------------------------	--------------------------------	------------------------	---------------------	--	--	--	--

TAPERED 859L • Pointed long, round



FG • ISO 314	 FG D33C FG D33	 FG D35C FG D35	 FG D36C FG D36	 FG D37C FG D37				
--------------	-----------------------	-----------------------	-----------------------	-----------------------	--	--	--	--

Colour code	Micron		Description
 544	150 µm	125 µm	Super coarse
 534	125 µm	106 µm*	Coarse
 524	106 µm	60/80/90 µm*	Standard
 524	80 µm		Medium
 514	50 µm		Golden Burs GB
 514	40 µm		Fine
 514	25 µm		Fine
 504	15 µm		Extra fine
 494	8 µm		Ultra fine

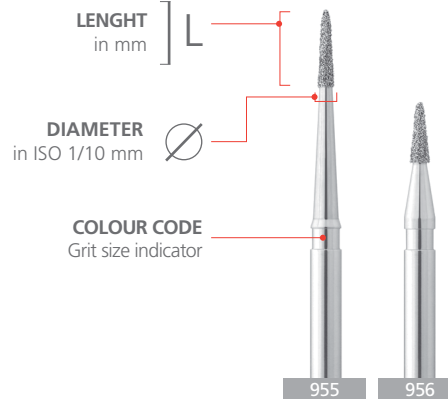





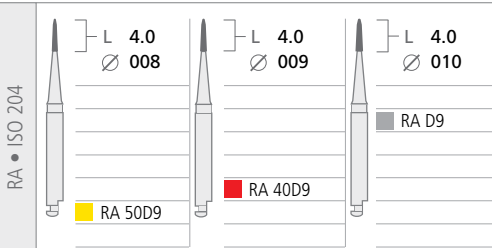
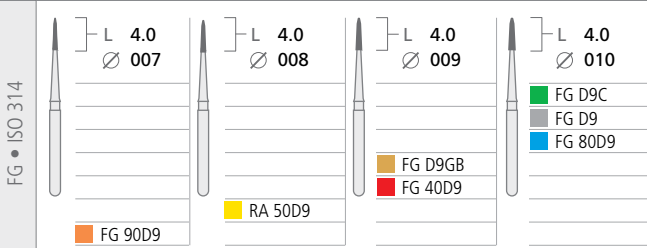



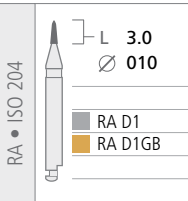
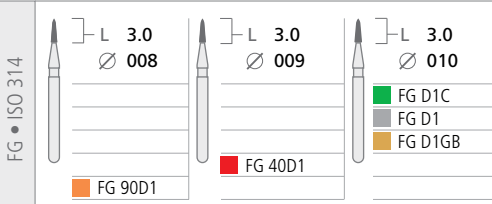

*Depending on the shape and size of the instruments, the grit size may differ from the specified value.

TAPERED 955 • Pointed short, round, long neck



TAPERED 956 • Pointed short



Colour code	Micron		Description
 544	150 µm	125 µm	Super coarse
 534	125 µm	106 µm*	Coarse
 524	106 µm	60/80/90 µm*	Standard
 524	80 µm		Medium
 514	50 µm		Golden Burs GB
 514	40 µm		Fine
 514	25 µm		Fine
 504	15 µm		Extra fine
 494	8 µm		Ultra fine

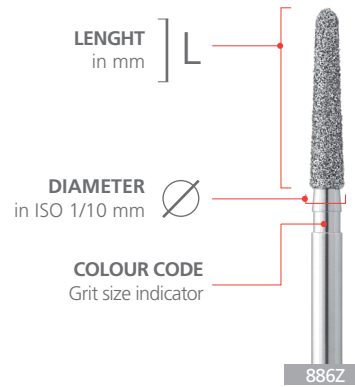

*Depending on the shape and size of the instruments, the grit size may differ from the specified value.

TAPERED 886Z • Pointed

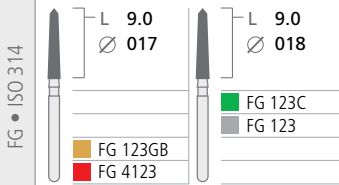
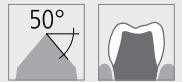

Intensiv HygienicTray

Instrument trays have become an indispensable support in the dental practice for the provision of all rotating instruments in the treatment routine. Intensiv offers various possibilities.

See page 73



Colour code	Micron		Description
544	150 µm	125 µm	Super coarse
534	125 µm	106 µm*	Coarse
524	106 µm	60/80/90 µm*	Standard
524	80 µm		Medium
514	50 µm		Golden Burs GB
514	40 µm		Fine
514	25 µm		Fine
504	15 µm		Extra fine
494	8 µm		Ultra fine

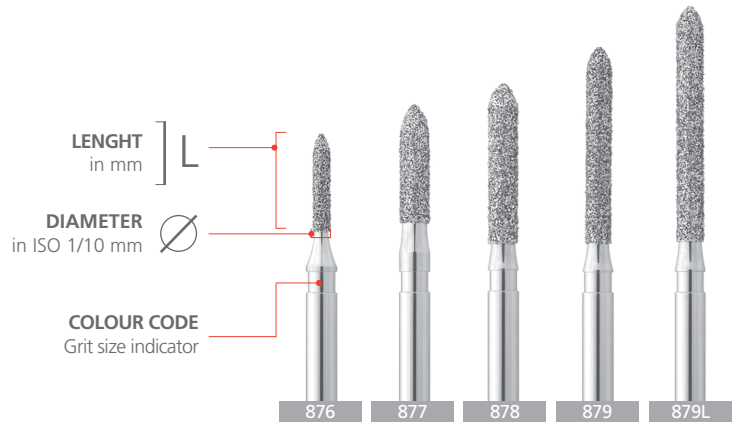

*Depending on the shape and size of the instruments, the grit size may differ from the specified value.

TORPEDO 876 • Short, slim

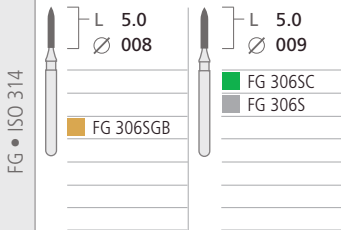

TORPEDO 877 • Short

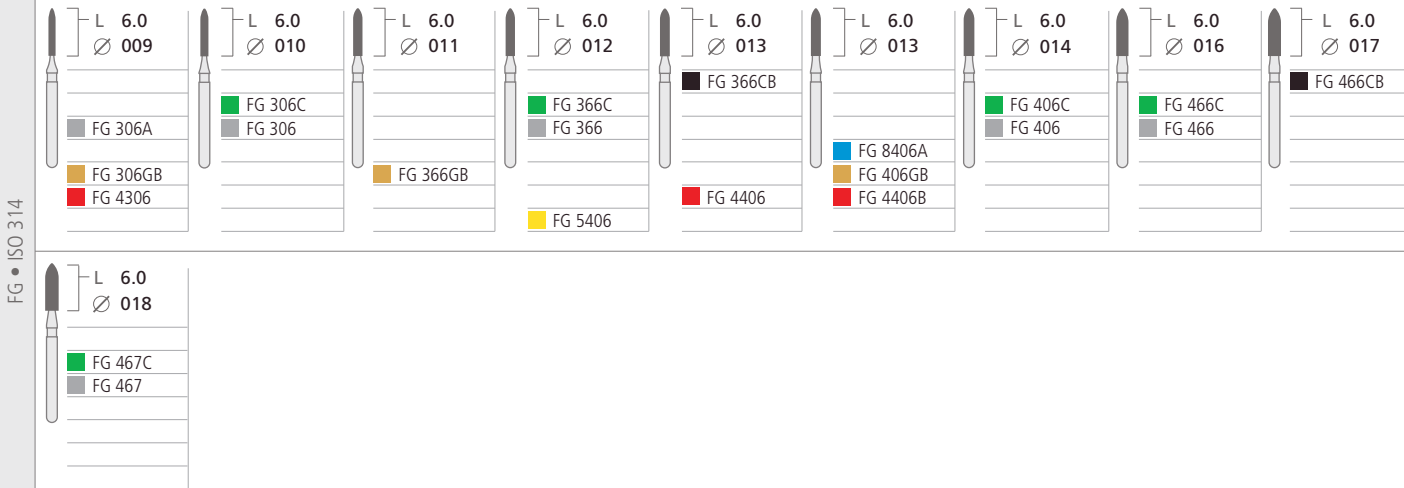

TORPEDO 878 • Normal



FG • ISO 314	L 8.0 ∅ 008	L 8.0 ∅ 009	L 8.0 ∅ 010	L 8.0 ∅ 011	L 8.0 ∅ 012	L 8.0 ∅ 013	L 8.0 ∅ 014	L 8.0 ∅ 015	L 8.0 ∅ 016
	FG 468	FG 469	FG 308SC FG 308S	FG 308GB FG 4308	FG 308C FG 308 FG 8308	FG 308CB FG 388GB FG 4388	FG 388C FG 388 FG 8388	FG 388CB FG 408GB FG 4408	FG 408C FG 408
FG • ISO 204	L 8.0 ∅ 017	L 8.0 ∅ 018	L 8.0 ∅ 011	L 8.0 ∅ 012					
	FG 408CB	FG 470C FG 470	RA 308GB RA 4308	RA 308					

TORPEDO 879 • Long



FG • ISO 314	L 10.0 ∅ 010	L 10.0 ∅ 010	L 10.0 ∅ 011	L 10.0 ∅ 011	L 10.0 ∅ 012	L 10.0 ∅ 012	L 10.0 ∅ 013	L 10.0 ∅ 014	L 10.0 ∅ 014
	FG 8040S	FG 3040SB	FG 4037	FG 310GB FG 4310	FG 310C FG 310 FG 8310	FG 4410	FG 3410	FG 310CB FG 410GB FG 4310B	FG 410C FG 410 FG 8410
FG • ISO 204	L 10.0 ∅ 015	L 10.0 ∅ 016	L 10.0 ∅ 018	L 10.0 ∅ 011	L 10.0 ∅ 011	L 10.0 ∅ 012			
	FG 410CB	FG 471C FG 471	FG 472C FG 472	RA 4037	RA 310GB	RA 310C RA 310			

TORPEDO 879L • X-long



FG • ISO 314	L 12.0 ∅ 012	L 12.0 ∅ 013	L 12.0 ∅ 014	L 12.0 ∅ 015	L 12.0 ∅ 016
	FG 473LC FG 473L		FG 474LC FG 474L	FG 410LC FG 410L FG 8410L	FG 410LCB
<p>FG 4410L FG 5410L</p> <p>FG 410LGB</p>					

Colour code	Micron		Description
544	150 µm	125 µm	Super coarse
534	125 µm	106 µm*	Coarse
524	106 µm	60/80/90 µm*	Standard
524	80 µm		Medium
514	50 µm		Golden Burs GB
514	40 µm		Fine
514	25 µm		Fine
504	15 µm		Extra fine
494	8 µm		Ultra fine

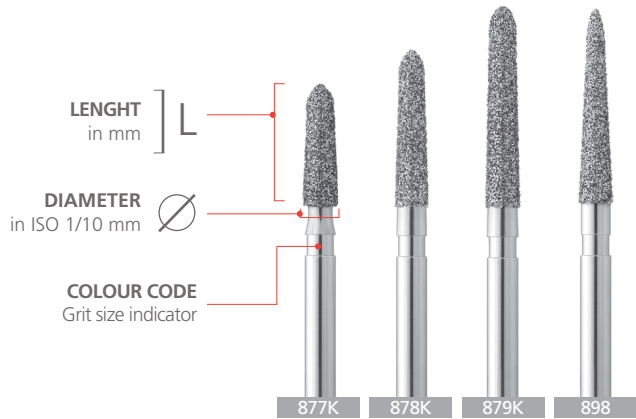

*Depending on the shape and size of the instruments, the grit size may differ from the specified value.

TORPEDO 877K • Short, conical



FG • ISO 314	L 6.0 ∅ 011	L 6.0 ∅ 012	L 6.0 ∅ 013	L 6.0 ∅ 014	L 6.0 ∅ 015	L 6.0 ∅ 016	L 6.0 ∅ 017	L 6.0 ∅ 017	L 6.0 ∅ 018
	FG 161GB FG 4161	FG 161C FG 161	FG 4161N FG 5062	FG 161NC FG 161N FG 4062	FG 162GB FG 4162	FG 162C FG 162	FG 162CB	FG 163GB FG 4163	FG 163C FG 163
	L 6.0 ∅ 019	L 6.0 ∅ 021							
	FG 163CB	FG 164C FG 164							

RA • ISO 204	L 6.0 ∅ 013	L 6.0 ∅ 014
	RA 5062	RA 4062

Intensiv PrepTwins

RA • ISO 204	L 6.0 ∅ 020
	RA PT877K/6 RA PT4877K/6 RA PT5877K/6

Diamond Polymer Finisher for refined shaping of all preparations.

See pages 100-101



TORPEDO 878K • Conical



FG • ISO 314	 L 8.0 Ø 010 FG 5181	 L 8.0 Ø 011 FG 181GB FG 4181	 L 8.0 Ø 012 FG 181C FG 181	 L 8.0 Ø 013 FG 181CB FG 4181N	 L 8.0 Ø 014 FG 181NC FG 181N FG 5182	 L 8.0 Ø 015 FG 182GB FG 4182	 L 8.0 Ø 016 FG 182C FG 182	 L 8.0 Ø 017 FG 182CB FG 183GB	 L 8.0 Ø 018 FG 183C FG 183
	 L 8.0 Ø 020 FG 184GB FG 4184	 L 8.0 Ø 021 FG 184C FG 184	 L 8.0 Ø 022 FG 184CB FG 185GB FG 4185	 L 8.0 Ø 023 FG 185C FG 185	 L 8.0 Ø 024 FG 185CB				

TORPEDO 879K • Long, conical



FG • ISO 314	 L 10.0 Ø 012 FG 190C FG 190	 L 10.0 Ø 013 FG 191GB	 L 10.0 Ø 014 FG 191C FG 191	 L 10.0 Ø 015 FG 191CB FG 192GB FG 4192	 L 10.0 Ø 016 FG 192C FG 192	 L 10.0 Ø 017 FG 192CB FG 193GB FG 4193	 L 10.0 Ø 018 FG 193C FG 193 FG 9195	 L 10.0 Ø 019 FG 193CB FG 4194 FG 5195	 L 10.0 Ø 020 FG 194C FG 194 FG 4195
	 L 10.0 Ø 021 FG 194CB FG 195 FG 8195	 L 10.0 Ø 023 FG 196C FG 196							

TORPEDO 898 • Long, slim, conical



FG • ISO 314	 L 10.0 Ø 013 FG 101GB FG 4101	 L 10.0 Ø 014 FG 101C FG 101	 L 10.0 Ø 015 FG 101CB FG 102LGB FG 4102L	 L 10.0 Ø 016 FG 102LC FG 102L	 L 10.0 Ø 017 FG 103GB FG 4103	 L 10.0 Ø 018 FG 103C FG 103	 L 10.0 Ø 020 FG 104GB	 L 10.0 Ø 021 FG 104C FG 104
	 L 10.0 Ø 010 FG 5102L							

Colour code	Micron		Description
544	150 µm	125 µm	Super coarse
534	125 µm	106 µm*	Coarse
524	106 µm	60/80/90 µm*	Standard
524	80 µm		Medium
514	50 µm		Golden Burs GB
514	40 µm		Fine
514	25 µm		Fine
504	15 µm		Extra fine
494	8 µm		Ultra fine

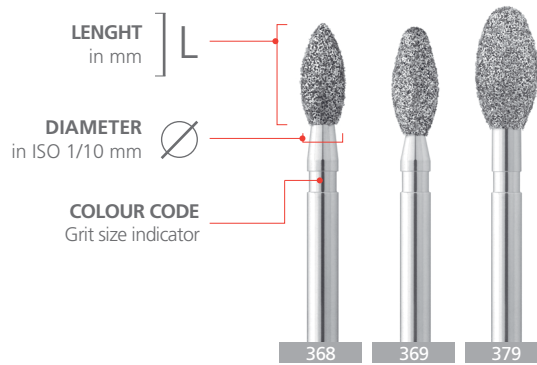

*Depending on the shape and size of the instruments, the grit size may differ from the specified value.

FOOTBALL 368 • Bud conical



FG • ISO 314	L 2.5 Ø 010 FG 252A	L 2.5 Ø 011 FG 254GB FG 4254	L 2.5 Ø 012 FG 254C FG 254	L 3.0 Ø 012 FG 5253	L 3.0 Ø 013 FG 4253	L 3.0 Ø 014 FG 253C FG 253	L 3.2 Ø 016 FG 252	L 3.5 Ø 016 FG 5255A	L 3.5 Ø 017 FG 255AGB FG 4255A
	L 3.5 Ø 018 FG 255AC FG 255A FG 8255A	L 5.0 Ø 020 FG 9255	L 5.0 Ø 021 FG 3255 FG 5255	L 5.0 Ø 022 FG 8255 FG 255GB FG 4255	L 5.0 Ø 023 FG 255C FG 255	L 5.0 Ø 024 FG 255CB			
FG Long • ISO 315	L 5.0 Ø 021 FGL 5255	L 5.0 Ø 023 FGL 255C FGL 255							
RA • ISO 204	L 2.5 Ø 011 RA 254GB	L 2.5 Ø 012 RA 254C RA 254	L 3.5 Ø 016 RA 5255A	L 3.5 Ø 017 RA 255AGB	L 3.5 Ø 018 RA 255A	L 5.0 Ø 021 RA 5255	L 5.0 Ø 022 RA 255GB RA 4255	L 5.0 Ø 023 RA 255C RA 255	

Colour code	Micron		Description
544	150 µm	125 µm	Super coarse
534	125 µm	106 µm*	Coarse
524	106 µm	60/80/90 µm*	Standard
524	80 µm		Medium
514	50 µm		Golden Burs GB
514	40 µm		Fine
514	25 µm		Fine
504	15 µm		Extra fine
494	8 µm		Ultra fine

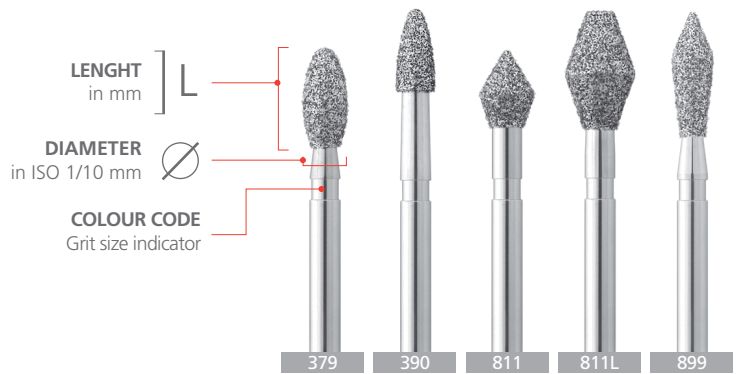

*Depending on the shape and size of the instruments, the grit size may differ from the specified value.

FOOTBALL 379 • Eggform, slim



FG • ISO 314	L 3.5 ∅ 016	L 3.5 ∅ 017	L 5.0 ∅ 020	L 5.0 ∅ 021	L 5.0 ∅ 022	L 5.0 ∅ 022	L 5.0 ∅ 023	L 5.0 ∅ 024
		FG 250AC FG 250A					FG 250C FG 250 FG 8250	FG 250CB
	FG 250AGB			FG 3250 FG 5250	FG 250GB FG 4250	FG 4250B		
			FG 9250					

RA • ISO 204	L 5.0 ∅ 021	L 5.0 ∅ 022	L 5.0 ∅ 023
			RA 250 RA 8250
	RA 3250 RA 5250	RA 250GB RA 4250	

FOOTBALL 390 • Grenade



FG • ISO 314	L 3.0 ∅ 014	L 3.0 ∅ 015	L 3.0 ∅ 016	L 4.0 ∅ 018	L 4.0 ∅ 019	L 4.0 ∅ 020	L 4.0 ∅ 021
	FG 4274 FG 3274 FG 5274 FG 9274	FG 274GB	FG 274C FG 274			FG 274NGB FG 4274N	FG 274NC FG 274N
				FG 3274N FG 5274N			
			FG 9274N				

RA • ISO 204	L 3.0 ∅ 014	L 3.0 ∅ 015	L 3.0 ∅ 016
	RA 4274 RA 3274 RA 5274 RA 9274	RA 274GB	RA 274

FOOTBALL 811 • Palatal grinder short



FG • ISO 314

	L 4.0 Ø 028	L 4.0 Ø 029	L 4.0 Ø 030	L 4.5 Ø 033	L 4.5 Ø 034	L 5.0 Ø 037
	FG 198GB FG 4198	FG 198C FG 198	FG 198CB	FG 198AC FG 198A	FG 198ACB	FG 197C FG 197

FOOTBALL 811L • Double cone long



FG • ISO 314

	L 6.0 Ø 036	L 6.0 Ø 037	L 6.0 Ø 038
	FG 241GB FG 4241	FG 241C FG 241	FG 241CB

FOOTBALL 899 • Palatal grinder, slim



FG • ISO 314

	L 6.5 Ø 019	L 6.5 Ø 020	L 6.5 Ø 021	L 7.0 Ø 024	L 7.0 Ø 025	L 7.0 Ø 026	L 7.0 Ø 027
	FG 3243 FG 5243 FG 9243	FG 243GB FG 4243	FG 243C FG 243	FG 9245	FG 5245	FG 245GB FG 4245	FG 245C FG 245

Intensiv PrepTwins



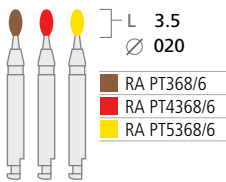



RA • ISO 204

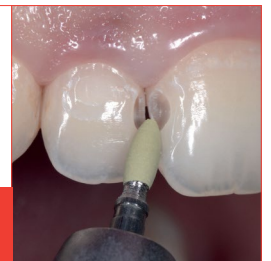

Diamond Polymer Finisher for refined shaping of all preparations.

See
pages
100-101



Colour code	Micron		Description
 544	150 µm	125 µm	Super coarse
 534	125 µm	106 µm*	Coarse
 524	106 µm	60/80/90 µm*	Standard
 514	50 µm		Golden Burs GB
 514	40 µm		Fine
 504	15 µm		Extra fine

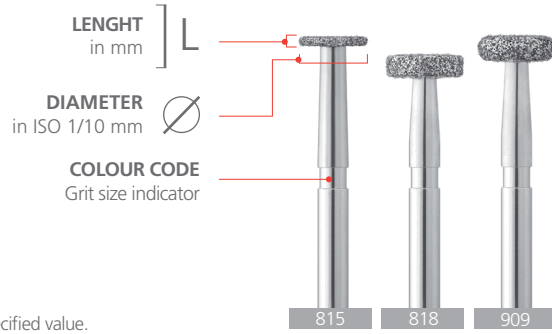

*Depending on the shape and size of the instruments, the grit size may differ from the specified value.

WHEEL 815 • Slim

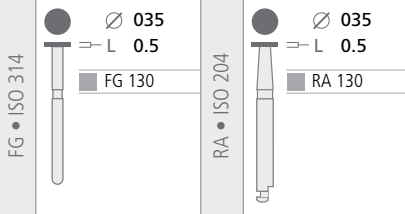

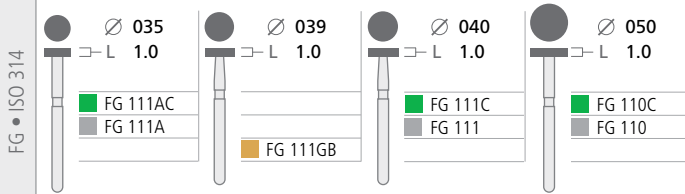

WHEEL 818

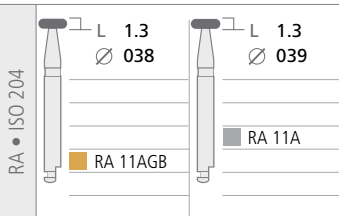
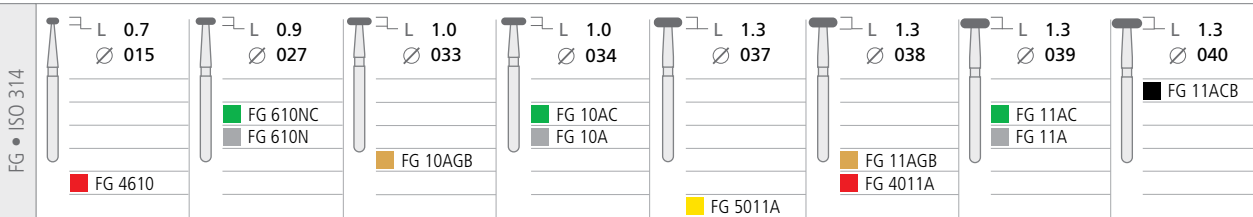

WHEEL 909 • Wide



Colour code	Micron		Description
 534	125 µm	106 µm*	Coarse
 524	106 µm	60/80/90 µm*	Standard
 514	50 µm		Golden Burs GB

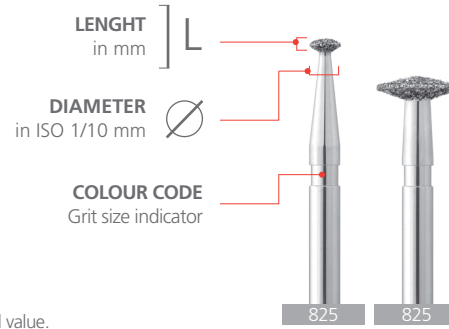

*Depending on the shape and size of the instruments, the grit size may differ from the specified value.

LENTICULAR 825 • Small

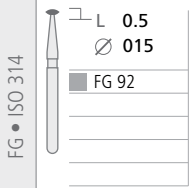

LENTICULAR 825

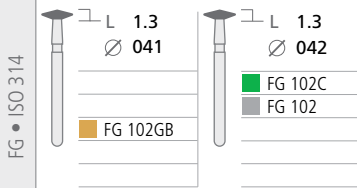







Intensiv HygienicTray

Instrument trays have become an indispensable support in the dental practice for the provision of all rotating instruments in the treatment routine. Intensiv offers various possibilities.

See
page 73



Colour code	Micron		Description
 534	125 µm	106 µm*	Coarse
 524	106 µm	60/80/90 µm*	Standard
 524	80 µm		Medium
 514	40 µm		Fine
 514	25 µm		Fine
 504	15 µm		Extra fine

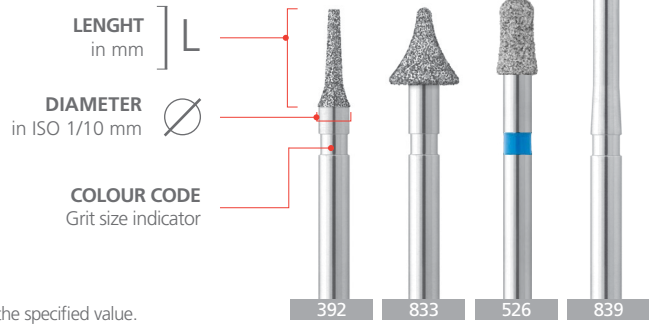

*Depending on the shape and size of the instruments, the grit size may differ from the specified value.

INTERDENTAL 392 • Short, tapered

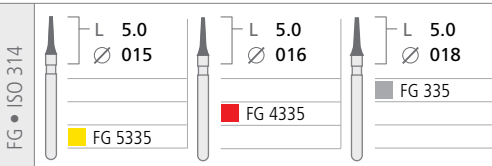

CAVITY MARGIN TRIMMER 833

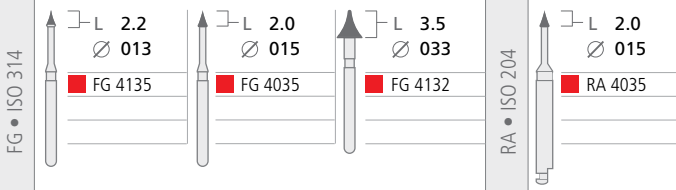



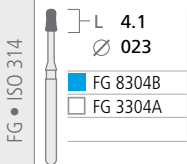

HEMISPHERICAL 526 • Concave side

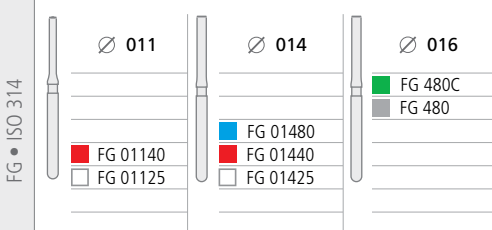

CYLINDER 839 • End-coated only



Colour code	Micron		Description
 534	125 µm	106 µm*	Coarse
 524	106 µm	60/80/90 µm*	Standard
 514	40 µm		Fine
 504	15 µm		Extra fine

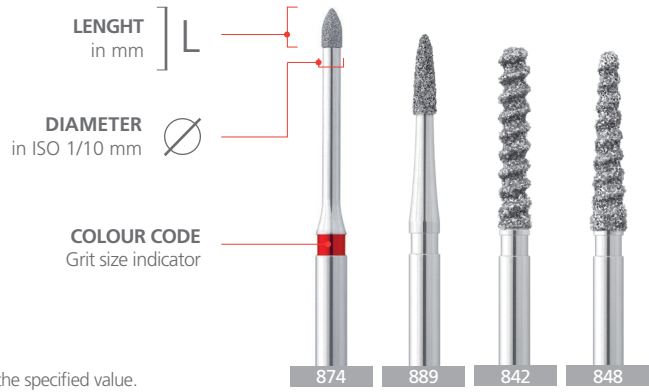

*Depending on the shape and size of the instruments, the grit size may differ from the specified value.

TORPEDO 874 • Short

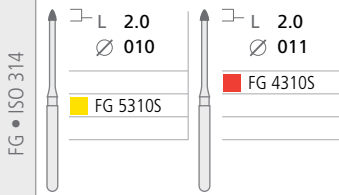

FLAME 889 • Long neck

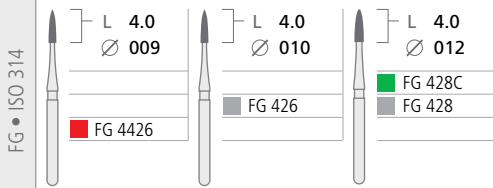

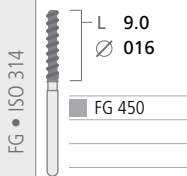

CYLINDRICAL 842 • Spiral groove

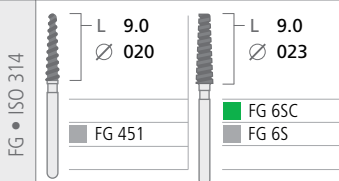

CONE 848 • Spiral groove



Colour code	Micron		Description
 534	125 µm	106 µm*	Coarse
 524	106 µm	60/80/90 µm*	Standard

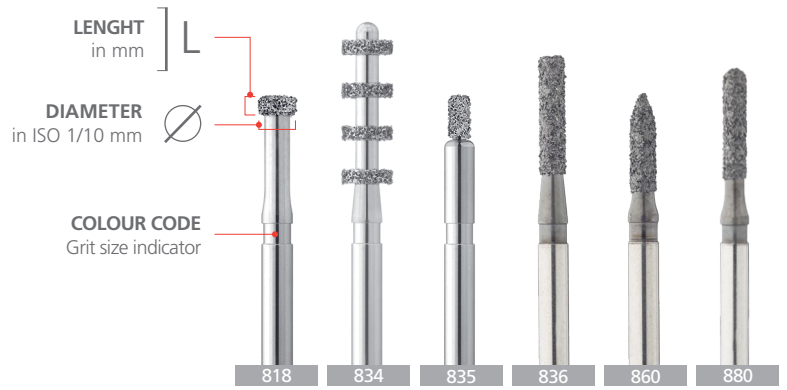

*Depending on the shape and size of the instruments, the grit size may differ from the specified value.

DEPTH MARKER 818 • X-small

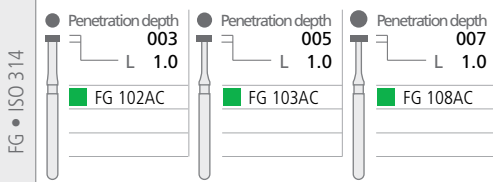

DEPTH MARKER 834 • Multi

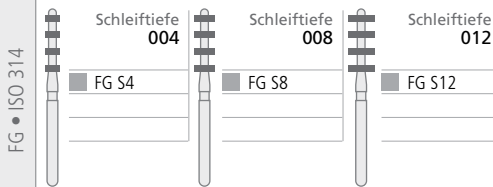

DEPTH MARKER 835 • X-short

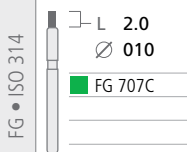

CYLINDER 836 • Intensiv ZirconCut Prosthetics, edge 90°

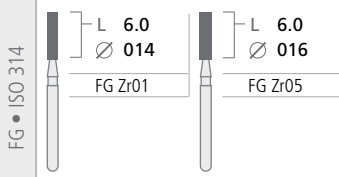

CYLINDER 860 • Intensiv ZirconCut Prosthetics, flame

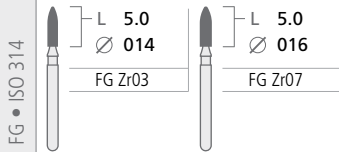

CYLINDER 880 • Intensiv ZirconCut Prosthetics, round

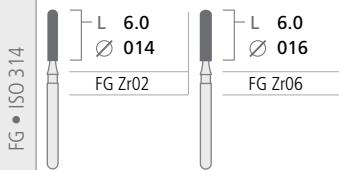

Intensiv ZirconCut

Cutting zirconia ceramic restorations is a major challenge in dental clinics today. The material is very compact and extremely hard. Adhesive cementation can lead to hardly removable anchorage of crowns and bridges. Intensiv ZirconCut special diamond instruments are suitable for more efficient cutting of zirconia ceramic restorations.

See
pages
24-25



Intensiv Cutting Instruments

New

Complementary instrument selection to the Diamant instrument range

In restorative therapies the complete excavation of decayed dentine is a mandatory step. The use of precise and efficient rotating cutting instruments allows for tactile perception of healthy dental tissue. In orthodontics, all residues of composite resins used for bracket bonding must be completely removed, and the tooth surfaces polished to achieve their natural roughness. For the removal of crowns, instruments which allow minimum separation procedure time without causing vibration are necessary.



Product Description

- Cutting instruments in different shapes: ball, pear, cylinder, football
- Available in different diameters in FG/RA shank
- Stable and precisely defined instrument tip

Indications

- Excavation of decayed dentine
- Cutting of metal and metal-ceramic crowns and bridges
- Removal of adhesive material in orthodontics

01: Dr. Francesco Garino, Turin, Italy
02: Dr. Alessandro Devigus, Bülach, Switzerland
03: Prof. Antonio Cerutti, Brescia, Italy

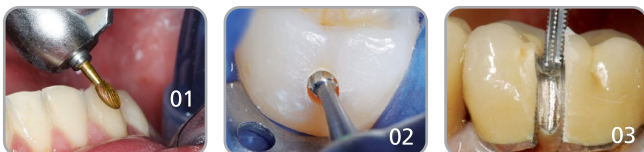

Benefits

- Excellent cutting performance
- Optimal strength, performance and durability
- Concentric rotation of the instruments
- Swiss Machining

Clinical pictures

- 01 Debonding with Intensiv Cutting Instrument
- 02 Excavation of carious dentin with instrument Intensiv Cutting Instrument
- 03 Metal crown separation with Intensiv Cutting Instrument



ExcavatingCutter

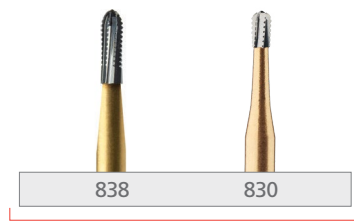



















CrownCutter



DebondingCutter



BALL 801

ExcavatingCutter

FG • ISO 500	 Ø 012 FGCU80012	 Ø 014 FGCU80014	 Ø 016 FGCU80016	 Ø 018 FGCU80018	 Ø 021 FGCU80021	 Ø 023 FGCU80023
RA • ISO 500	 Ø 012 RACU80012	 Ø 014 RACU80014	 Ø 016 RACU80016	 Ø 018 RACU80018	 Ø 021 RACU80021	 Ø 023 RACU80023
RA • ISO 500	 Ø 012 RACU83012	 Ø 014 RACU83014	 Ø 016 RACU83016	 Ø 018 RACU83018	 Ø 021 RACU83021	 Ø 023 RACU83023



PEAR 830R

ExcavatingCutter

FG • ISO 500	 L 1.9 Ø 008 FGCU87008	 L 1.8 Ø 010 FGCU87010
--------------	---	---



CYLINDER 838 • Rounded

CrownCutter

FG • ISO 500	 L 3.8 Ø 010 FGCU20010	 L 4.0 Ø 012 FGCU20012
--------------	---	---

PEAR 830 • Convex tip



CrownCutter

FG • ISO 500	 L 1.9 Ø 008 FGCU25008	 L 2.0 Ø 010 FGCU25010
--------------	---	---

FOOTBALL 379

DebondingCutter

FG • ISO 500	 L 4.2 Ø 023 FGCU60023
--------------	---

L: Length in mm | Ø: Diameter in ISO 1/10 mm | Schank type RA:  | Schank type FG: 

Trays



Intensiv
Proxoshape Tray

Trays

Intensiv HygienicTray	73
Intensiv ProxoshapeTray	74
Intensiv Ortho-StripsTray	75
Intensiv InstrumentTray	76
Intensiv IPRTay	77

Intensiv HygienicTray

Resistant high quality stainless steel instrument tray for the arrangement of rotating instruments for routine treatment protocols

Instrument trays for the permanent availability of all rotating instruments for routine treatment protocols have become an indispensable support in dental clinics. The Intensiv HygienicTray offers the appropriate solution. Dental clinic processes have become standardized by the availability of the complete set of commonly used rotating instruments.

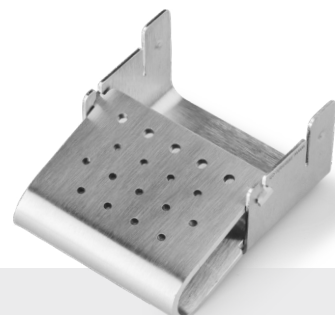

REF HT1000

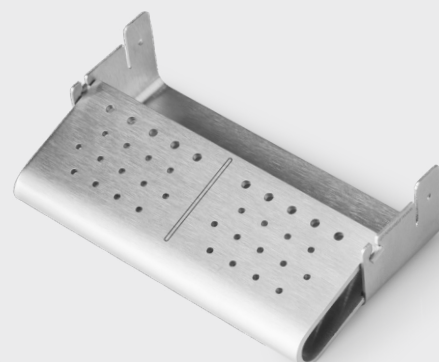

REF HT2000

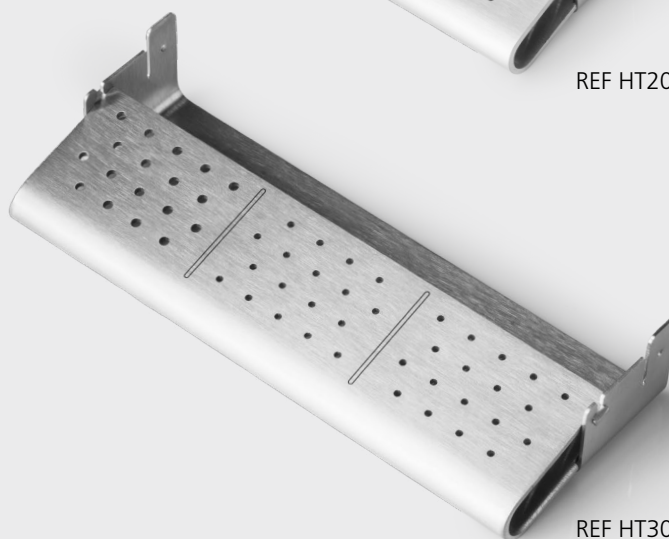

REF HT3000

Product Description

- Can be disassembled into different parts made of high quality stainless steel
- Without hard to reach fissures and hollows
- Rounded edges
- Height: suitable for standard sterilization trays

REF HT1000:

- 2 separable parts: foldable cover; instrument tray
- 13 FG and 5 RA instrument holders
- Ergonomic instrument access due to low and inclined tray position
- Dimensions: 50x40x30 mm (LxWxH)

REF HT2000:

- 2 separable parts: foldable cover; instrument tray
- 26 FG and 10 RA instrument holders
- Ergonomic instrument access due to low and inclined tray position
- Dimensions: 104x44x30 mm (LxWxH)

REF HT3000:

- 2 separable parts
- 36 FG and 18 RA instrument holders
- Ergonomic instrument access due to low and inclined tray position
- Dimensions: 150x44x30 mm (LxWxH)

Application

- Organization of standard instruments for all routine treatment protocols
- Storage and transport of rotary instruments

Benefits

- Organization and availability of commonly used rotating instruments
- Easy instrument removal due to irregular arranged position of instruments
- Hygienic due to 2 individual parts without hard to reach fissures and hollows
- Durable, resistant and sterilizable stainless steel

Intensiv ProxoshapeTray

Compact stainless steel tray with coloured silicone holders for the support of Intensiv Proxoshape oscillating files

During the processes in the dental practice, it is important to benefit from a support which is safe, hygienic, sterilizable and customizable in content. The identification of the instrument to be used has to be clear and immediate. The storage of the files should be carried out in complete safety.



REF PST500

Product Description

- Tray in stainless steel, consisting in a base and lid
- The Tray has an internal folding support with nine holes suitable to support sterilisable coloured silicone holders
- Dimensions: 87x51x14 mm (LxWxH)
- The Tray has slots for the disinfection liquid to flow through it
- Coloured silicone holders allow the arrangement of different oscillating Intensiv files

- 01 Easy identification of Intensiv files
- 02 Secure file removal

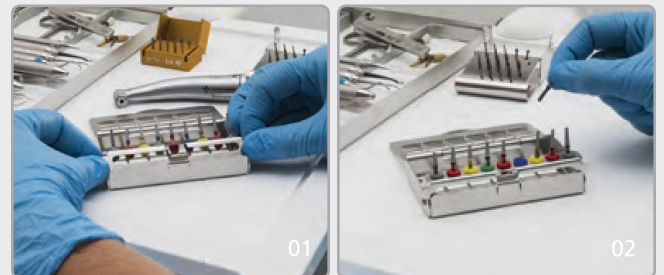

Bur-shank silicone holders									
REF	056green/10	056grey/10	056blu/10	056brown/10	056red/10	056white/10	056yellow/10	056orange/10	056ass/8
µm (the grit size is related to the strips)	125	90	80	60	40	25	15	08	

All coloured silicone holders are available in packaging of 10 pieces or in assortment of 8 pieces. 9 silicone holders as shown in the picture are delivered free with the Tray. The desired silicone holders are to be ordered with the Tray

Application

- Secure storage of Intensiv oscillating files in the dental practice

Benefits

- Intensiv files are assigned according to colour/grain
- Coloured silicone supports for individual combination
- Compact and light
- Suitable for disinfection and sterilization
- Storage and transport in complete safety of Intensiv files

Intensiv Ortho-StripsTray

Compact stainless-steel tray with coloured silicone supports for the placement of the Intensiv Ortho-Strips

During the processes in the dental practice, it's important to benefit from a support which is safe, hygienic, sterilizable and customizable in the content. The identification of the instrument to be used has to be clear and immediate. The storage of the strips should be carried out in complete safety.











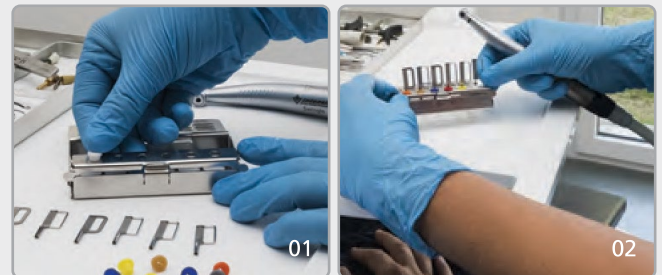





REF OST400

Product Description

- Tray in stainless steel, consisting in a base and lid
- The Tray has an internal folding support with six holes suitable to support sterilisable coloured silicone holders
- Dimensions: 87x51x14 mm (LxWxH)
- The Tray has slots for the disinfection liquid to flow through it
- Coloured silicone holders allow the arrangement of six different Intensiv Ortho-Strips

- 01 Introduction of the coloured silicone supports in the Tray for the positioning of the Intensiv Ortho-Strips
- 02 Selection of Intensiv Ortho-Strips



Bur-shank silicone holders							       
REF	056blu/10	056brown/10	056red/10	056white/10	056yellow/10	056orange/10	056ass/8
µm (the grit size is related to the strips)	80	60	40	25	15	08	

All coloured silicone holders are available in packaging of 10 pieces or in assortment of 8 pieces. 8 silicone holders are delivered free with the Tray. The desired silicone holders are to be ordered with the Tray.

Application

- Secure storage of Intensiv Ortho-Strips in the dental practice

Benefits

- Intensiv Ortho-Strips are assigned according to colour/grain
- Coloured silicone supports for individual combination
- Compact and light
- Suitable for disinfection and sterilization
- Storage and transport in complete safety of Intensiv Ortho-Strips

Intensiv InstrumentTray

New

Compact, high quality stainless steel instrument tray for the storage and transport of long Intensiv instruments

During the processes in the dental practice, it's important to benefit from a support which is safe, hygienic, sterilizable and customizable in the content. The identification of the instrument to be used has to be clear and immediate. The instruments should be stored in absolute safety.



REF T600

Product Description

- Tray in stainless steel, consisting in a base and lid
- The Tray has an internal folding support with six holes suitable to support sterilisable coloured silicone holders
- Dimensions: 87x51x14 mm (LxWxH)
- Maximum instrument length 35 mm
- The Tray has slots for the disinfection liquid to flow through it
- Coloured silicone holders allow the assignment of six Intensiv instruments

01 Coloured silicone holders in the tray allow allocation of the Intensiv instruments

02 Selection of Intensiv instruments

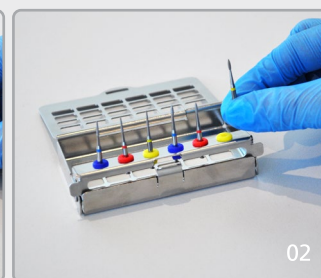

Bur-shank silicone holders									
REF	056green/10	056grey/10	056blu/10	056brown/10	056red/10	056white/10	056yellow/10	056orange/10	056ass/8
µm (the grit size is related to the strips)	125	90	80	60	40	25	15	08	

All coloured silicone holders are available in packaging of 10 pieces or in assortment of 8 pieces. 8 silicone holders are delivered free with the Tray. The desired silicone holders are to be ordered with the Tray.

Application

- Safe storage and transport of Intensiv instruments in the dental practice

Benefits

- The Intensiv instruments are available during the treatment according to the assignment of their use
- Coloured silicone supports for individual combination of the needed Intensiv instruments
- Compact and light
- Suitable for disinfection and sterilization
- Storage in complete safety of Intensiv instruments

Intensiv IPRTray

High-quality stainless steel instrument tray for storage and transport of the Intensiv IPR instruments

The Intensiv IPRTray enables a safe, hygienic, sterilizable support for IPR (interproximal reduction) instruments in orthodontics.

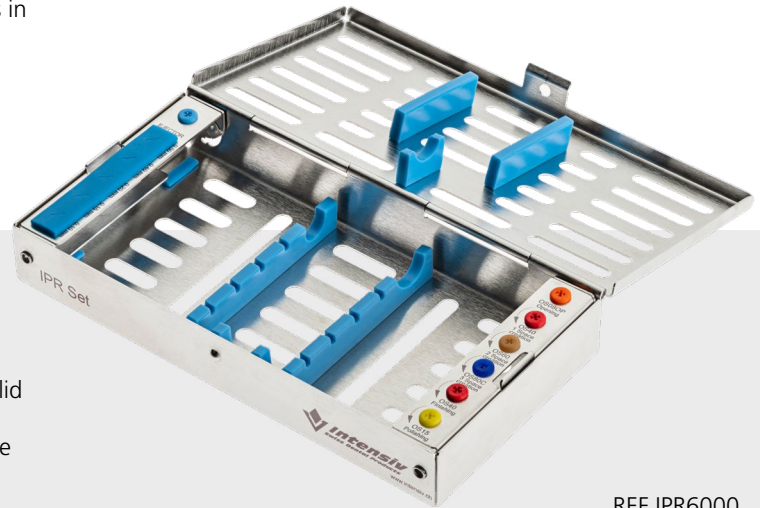

REF IPR6000

Product Description

- Tray in polished stainless steel, consisting in a base and lid connected by a hinge
 - Supports in sterilised coloured silicone for containing the instruments in a compact arrangement, suitable for the safe withdrawal and relocation of the instruments
 - Internal lateral folding supports that display the instruments' item number
 - Dimensions: 190x100x25mm (LxWxH)
 - Tray with slots for the disinfection liquid to flow inside it
-
- The Tray is designed to hold, through its silicone supports, the following instruments for mechanical and manual Orthodontic stripping:
 - 6 Intensiv Ortho-Strips
 - 1 Intensiv Swingle contra-angle
 - 1 Ejector for Intensiv Swingle
 - 2 Intensiv ProxoContour Coarse
 - 2 Intensiv ProxoPolish
 - 2 diamond-coated serrated Intensiv ApproxOpener
 - 5 Intensiv IPR Distance-Control

01 Easy recognition of the Intensiv instruments thanks to the marked position

02 Secure instrument removal

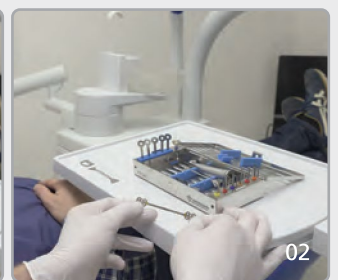
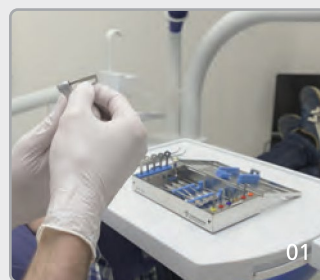

Application

- Safe storage and transport of the manual and mechanical instruments and of the contra-angle

Benefits

- The Intensiv instruments are to be assigned according to the marking
- Storage and transport in complete safety of Intensiv IPR Instruments



Intensiv Swingle
SWISS EDITION

Oscillating Instruments



Contra-angle

Intensiv Swingle	80
Intensiv Swingle SWISS EDITION	82

Restoration

Intensiv Proxoshape	84
Intensiv Bevelshape	86

Intensiv Swingle

The contra-angle with both functions, axially free rotating and axially fixed position

In case of abutments and cavities preparation, as well as restoration materials finishing, the most utilized system in the dental office is based on rotating instruments use. In individual cases, this results in restrictions with regard to precision and iatrogenic damage that preclude the use of rotary instruments. In such cases, it is advisable to use single-sided abrasive oscillating files or strips in addition to rotary instruments. Improving significantly the quality of the surfaces being worked on.



Product Description

THE DUAL CONTRA-ANGLE INTENSIV SWINGLE

For the use of oscillating files and strips (p. 90). The contra-angle Intensiv Swingle has 2 functions in conjunction: the freely rotating axial position to use with diamond coated files like Intensiv Proxoshape and fixed axial position with the application of oscillating files like Intensiv Bevelshape. The contra-angle head is of small size to allow an extensive view on the operating field.

- Contra-angle with integrated water spray and optional light
- Stroke 0.9 mm
- 20.000 oscillating movements with 40.000 rpm
- With toggle switch to choose free rotating or fixed position of files
- 12 different axial fixed positions on 360°
- File ejector and cleaning needle (water spray canals) are included in delivery

A simple to move toggle switch at the contra-angle head permits to choose between axially free rotating or axially fixed files.

Contra-angle with light: REF WG-69 LT
Contra-angle without light: REF WG-69 A

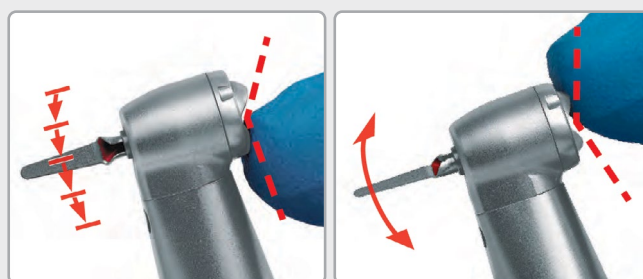

Indications

- Minimally invasive precise elaboration of preparations and finishing proximal surfaces restored
- Fast and efficient removal of filling excess, finishing and polishing of restorations

Benefits

- 2 applications with one contra-angle only, axially freely rotating or axially fixed files
- Extensive view on the operating field due to small size contra-angle head and light
- 20.000 oscillating strokes per minute for better grinding and polishing efficiency

Dr. Simona Giani, Varese, Italy
 Dr. Alessandro Devigus, Bülach, Switzerland

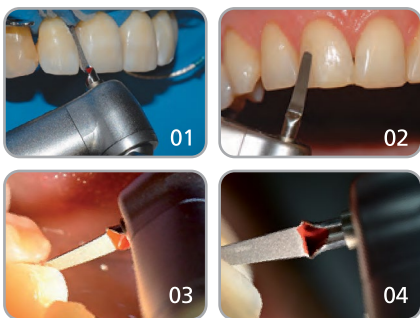

Clinical pictures

- 01 Interproximal finishing with Intensiv Swingle and Intensiv Proxoshape PS2
- 02 Finishing of vestibular surface with Intensiv Proxoshape PS2 and Intensiv Swingle
- 03 Application with light
- 04 Application without light



Intensiv Swingle

Intensiv Swingle,
 WG-69 LT Cons, W&H Synea, with light

Contra-angle, REF WG-69 LT*
 Ejector, REF 053
 Spray canal cleaner needle, REF 054

* Contra-angle without light: REF WG-69 A

Combined system for the best performance
 When treating interproximal restorations, the highest performance level with maximum benefit is guaranteed by the combination of:



Adjust Intensiv Swingle to its highest speed
 40.000 rpm (= 20.000 oscillations)



Press only until the file
 starts to bend slightly

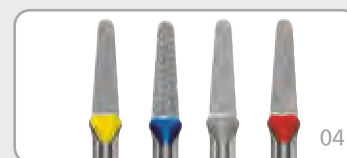
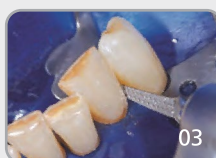

Diamond grain of the
 Proxoshape files is chosen
 according to the desired
 treatment objective

Intensiv Swingle

SWISS EDITION

Durable, refined and high-performing, including additional service package

In clinical applications the efficient use of a mutual contra-angle is required: the possibility to choose between the axially fixed position during removal of filling excess, and free axial rotation of the file while beveling or finishing of cervical restorations, creates added value for the dentist. Intensiv Swingle SWISS EDITION is a reciprocating contra-angle with a dual mechanism, realized with a new design for a secure grip and a special vitreous coating that improves its scratch resistance and durability.

This special glass coating permanently protects the surface from scratches, the original appearance is maintained over time. The new handle design offers a better external hygiene and a secure grip.



Contra-angle with light:
REF WG-69LT CPL

Contra-angle without light:
REF WG-69A CPL

Product Description

- New contra-angle handpiece design for a firm grip
- Special coating protects permanently against scratches
- Contra-angle with integrated water spray and optional light
- Stroke 0.9 mm
- 20.000 oscillating movements with 40.000 rpm
- With toggle switch to choose free rotating or fixed position of files
- 12 different axial fixed positions on 360°
- File ejector and cleaning needle (water spray canals) are included in delivery

A simple to move toggle switch at the contra-angle head permits to choose between axially free rotating or axially fixed files.

Toggle switch pushed down: locking the file in axially fixed position (12 positions, one every 30° over 360°). Application for precise reduction of approximal excess.

Toggle switch pushed up in neutral position: axially free rotation of file. Application for marginal polishing and bevelling.

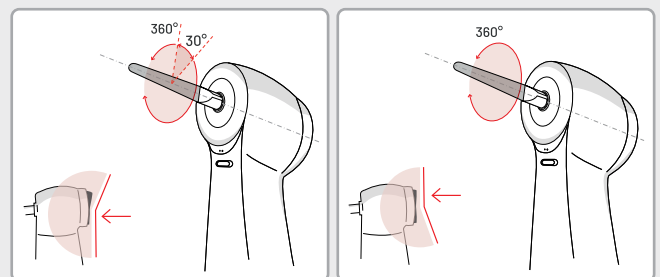

Indications

- Minimally invasive precise elaboration of preparations and finishing proximal surfaces restored
- Fast and efficient removal of filling excess, finishing and polishing of restorations

Benefits

- Lasting integrity of the contra-angle's surface, thanks to the scratch resistant and durable special coating
- 20.000 oscillations per minute for better use performance of files
- 3 year Warranty
- First maintenance service included in the purchase package

Dr. A. Devigus, Bülach, Switzerland



Clinical pictures

- 01 Separation of teeth to be treated with Intensiv Swingle with SWISS EDITION + PS2L, 40µm
- 02 Mechanical finishing of the restoration with Intensiv Swingle SWISS EDITION + PSF40, 40µm
- 03 Incisal edge preparation for Veneer with Intensiv Swingle SWISS EDITION + BS40, 40µm
- 04 Vestibular bevel finishing with Intensiv Swingle SWISS EDITION + BS15, 15µm

Intensiv Swingle SWISS EDITION, W&H Synea

REF WG-69 LT, W&H Synea, with light Contra-angle, REF WG-69LT SWISS EDITION* Ejector, REF 053
Cleaning needle, REF 054

* REF WG-69 A, W&H Syneam without light Contra-angle, REF WG-69A SWISS EDITION Ejectori, REF 053
Cleaning needle, REF 054

EXTRA:

- A 3 year warranty certificate for Intensiv Swingle SWISS EDITION
- Voucher for a free maintenance service of the contra-angle, to be performed within 24 months of the purchase

Intensiv Swingle SWISS EDITION is contained in a practical red metal box, sterilizable and reusable in different applications.



Intensiv Swingle
SWISS EDITION



Intensiv Proxoshape

Oscillating diamond-coated files for the removal of overhangs and finishing of proximal filling surfaces

Perfectly adapted and polished proximal filling surfaces and crown margins are a prerequisite for the maintenance of the health of the periodontium and the prevention of secondary caries. Proxoshape meets the requirements to correctly model the filling surfaces and margins and prepares them for the high gloss finish.



Product Description

Intensiv Proxoshape:

- 4 one-sided diamond coated files in grits: 125 µm, 90 µm, 50 µm, 40 µm, 15 µm
- 3 files with extended working surface, 11 mm
- 2 narrow files, 40µm and 15 µm
- 1 distal diamond-coated file, 3 mm, 15 µm
- Minimal metal thickness 0.2 mm

Intensiv Proxoshape Flexible:

- 3 single-sided diamond files in 60, 50, 40 and 15 µm
- 2 file lengths: 8.5 mm and 11 mm
- Minimal metal thickness 0.1 mm

Intensiv Proxoshape Coarse:

- One-sided diamond coated and perforated file, in 80 µm, 2 rows of perforation
- Minimal metal thickness 0.2 mm

All Intensiv Proxoshape are available in packages of 1, 3 or 6 pcs

Intensiv Proxoshape Set, REF 100
1 pcs of PS0, PS1, PS2, PS3, 1 Ejector, 1 Diakleen

Intensiv Proxoshape Set Optional, REF 115
1 pcs of PS0, PS1, PS2, PS3, PS1L, PS2L, PS3L, PS2S, PS3S, PS3G

Intensiv Proxoshape Flexible Set, REF 110
1 pcs of PSF60, PSF40, PSF15, PSF60L, PSF40L, PSF15L

Indications

- Removal of: Filling and cement overhangs
- Finishing and trimming of: proximal crown margins in gold or ceramic
- Contouring and finishing of: proximal restoration surfaces

Benefits

- Easier access to the interproximal space
- No iatrogenic damage to adjacent teeth
- Prevention of surface wave generation caused by rotating instruments

1-2) University of Brescia, Italy
 3-4) University of Zurich, Switzerland
 5-6) Dr. A. Devigus, Bülach, Switzerland



Clinical pictures

- 01 Interproximal restoration finishing with file PS2
- 02 Treatment of the zone underneath the reconstructed contact points without damaging the neighbouring teeth with the PS3 file
- 03 Finishing of the cervical margin with the PSF40L file
- 04 Finishing the interproximal restoration with the PSF15L file
- 05 Modeling with PSC80
- 06 Modeling with PSC80

Colour code	Micron	Description
534	125 µm	Coarse
524	90 µm	Standard
524	80 µm	Medium
514	50 µm	Golden Burs GB
524	60 µm	Medium
514	40 µm	Fine
504	15 µm	Extra fine
494	8 µm	Ultra fine

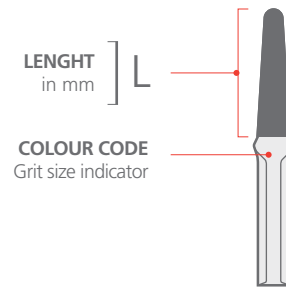

Standard – 0.2 mm	Standard – 0.2 mm	Standard – 0.2 mm	Standard – 0.2 mm	Standard – 0.2 mm	Standard – 0.2 mm	Standard – 0.2 mm	Standard – 0.2 mm	Standard – 0.2 mm
PS0	PS1	PS2	PS3	PS1L	PS2L	PS3L	PS2S	
PS3S	PS3G	PSC80	PS9	PS9S	PS50	PS50L		
Flexible – 0.1 mm	Flexible – 0.1 mm	Flexible – 0.1 mm	Flexible – 0.1 mm	Flexible – 0.1 mm	Flexible – 0.1 mm	Flexible – 0.1 mm	Flexible – 0.1 mm	Flexible – 0.1 mm
PSF60	PSF40	PSF15	PSF60L	PSF40L	PSF15L			

Intensiv Bevelshape

Oscillating diamond files for perfect bevelled edges and preparation margins

A key factor for an ideal cavity preparation for composite fillings, gold inlays and overlays is a precise margin bevelling with sharp edges. The single-side diamond coating helps to prevent iatrogenic damage to adjacent teeth and injury to periodontal tissue.



Product Description

- Axially curved files with distally bent ends
- 3 files diamond-coated over the entire convex working length in grits 40, 25, 15 µm
- 3 files diamond-coated over the convex distal end only in grits 40, 25 and 15 µm

REF 103, Intensiv Bevelshape Set.
All Intensiv Bevelshape are available in packages of 1, 3 or 6 pcs

Colour code	Micron	Description
■ 514	40 µm	Fine
□ 514	25 µm	Fine
■ 504	15 µm	Extra fine

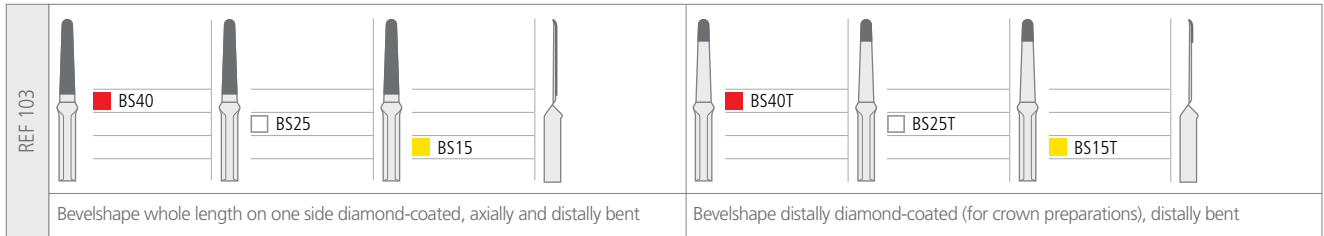

Indications

- Margin bevelling for anterior composites, composite slots, inlays and overlays
- Margin finishing in veneer preparations
- Crown preparations
 - Margin finishing in chamfer preparation
 - Bevelling in shoulder preparation

Benefits

- Polished and clearly outlined profiles with perfect sharp cut edges
- No microfractures and no accidental chipping of dental enamel prisms
- Prevention of enamel defects and grooves on the preparation margin

University of Zurich, Switzerland



Clinical pictures

- 01 The file allows the bevelling of a cervical shoulder
- 02 Margin finishing in veneer preparation with BS40 or BS40T
- 03 Margin bevelling in class IV restorations

Intensiv Swingle

🇨🇭 SWISS EDITION





Intensiv OST400Set01/6

Instruments for Orthodontics



Contra-angle

Intensiv Swingle 90

Mechanical Instruments

Intensiv Ortho-Strips System 92

Intensiv Ortho-Strips System, Central 94

Manual Instruments

Intensiv OST400Set01 96

Intensiv ApproxOpener 97

Intensiv IPR-DistanceControl 97

Intensiv Swingle



Calibrated and efficient stripping in orthodontics

In clinical applications the efficient use of an oscillating contra-angle is required: the possibility to choose between the axially fixed position and free axial rotation within the same treatment (for space creation, as well as for finishing and polishing approximal enamel), creates added value for the dentist.



Product Description

The dual contra-angle Intensiv Swingle for application with oscillating Intensiv Ortho-Strips.

The contra-angle Intensiv Swingle combines both functions:

- free axial rotating of the strip, being applied during finishing and polishing of prepared surfaces
 - fixed axial position (12 positions at each 30° within 360°) for exact positioning of the strip, being applied in the resolution of the contact point and for enamel reduction
- Moreover, the small sized contra-angle head allows a significantly improved view of the operating field.
- Contra-angle with integrated water spray and optional light
 - Stroke 0.9 mm
 - 20.000 oscillating movements with 40.000 rpm
 - With toggle switch to choose free rotating or fixed position of strips
 - 12 different axial fixed positions on 360°
 - File ejector and cleaning needle (water spray canals) are included in delivery

Contra-angle with light: REF WG-69 LT
Contra-angle without light: REF WG-69 A

A simple to move toggle switch at the contra-angle head permits to choose between axially free rotating or axially fixed files.

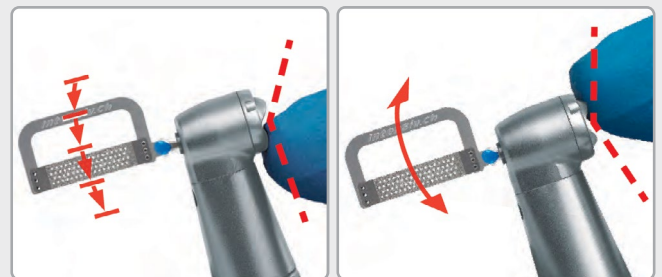

Indications

- Interproximal space creation by stripping according to the IPR protocol (InterProximalReduction) in orthodontic treatments
- Finishing and final polishing of the treated dental surfaces

Benefits

- Safe, efficient and precise interproximal enamel reduction as part of orthodontic treatment
- Easy, controlled opening of the contact points
- Homogeneous and smooth surfaces

Dr. Francesco Garino, Turin, Italy

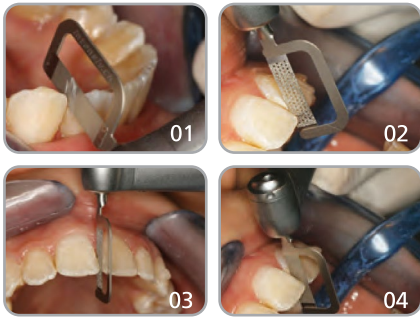

Clinical pictures

- 01 Opening of interdental space with Intensiv Ortho-Strips System, Opener
- 02 Calibrated and efficient removal of enamel with Intensiv Ortho-Strips und Intensiv Swingle
- 03 Application in Orthodontics during stripping with Intensiv Ortho-Strips and Intensiv Swingle
- 04 Finishing & polishing with Intensiv Ortho-Strips System, Polishing



Intensiv Swingle

Intensiv Swingle,
WG-69 LT Ortho, W&H Synea, with light

Contra-angle, REF WG-69 LT*
Ejector, REF 053
Spray canal cleaner needle, REF 054

* Contra-angle without light: REF WG-69 A

Intensiv Ortho-Strips
for orthodontics (clinical IPR treatments)

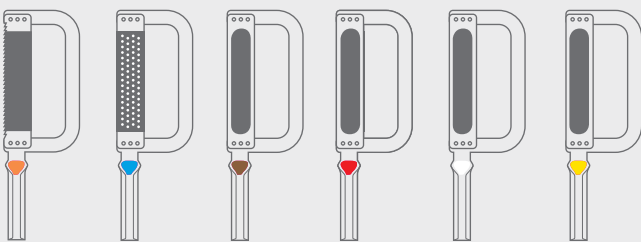

- OS08OP-DS, Opener, 8 μ m
- OS80XC-DS, Extracoarse, 80 μ m
- OS60C-CEN-DS, Coarse, 60 μ m
- OS40M-CEN-DS, Medium, 40 μ m
- OS25F-CEN-DS, Fine, 25 μ m
- OS15POL-CEN-DS, Polishing, 15 μ m

Intensiv Ortho-Strips System



Oscillating diamond strips for the double-sided or one-sided interdental reduction of the tooth size in orthodontics

When opening the interdental space and reducing, finishing and polishing enamel in orthodontics, care must be taken to avoid grooves and scratches. It is also important to proceed systematically, following a coarse-to-fine sequence in selecting grits. Unlike manual strips, the Intensiv Ortho-Strips System provides rapid, controlled enamel reduction followed by polishing without unnecessary removal of healthy tooth substance.



Product Description

- Flexible strips, double-sided or one-sided diamond coating
- 6 different grits:
 - 08 µm, orange, opening
 - 80 µm, blue, space creation
 - 60 µm, brown, reduction
 - 40 µm, red, contouring
 - 25 µm, white, finishing
 - 15 µm, yellow, polishing
- Sterilizable

Intensiv Ortho-Strips System, Double-Sided, REF OSSet02/6
Assortment of 6 oscillating strips

- OS08OP-DS
- OS80XC-DS
- OS60C-DS
- OS40M-DS
- OS25F-DS
- OS15POL-DS

Intensiv Ortho-Strips System, Left-Sided, REF OSSet02L/6
Assortment of 6 oscillating strips

- OS08OP-L
- OS80XC-L
- OS60C-L
- OS40M-L

- OS25F-L
- OS15POL-L

Intensiv Ortho-Strips System, Right-Sided, REF OSSet02R/6
Assortment of 6 oscillating strips

- OS08OP-R
- OS80XC-R
- OS60C-R
- OS40M-R
- OS25F-R
- OS15POL-R



All Intensiv Ortho-Strips Double-Sided and Intensiv Ortho-Strips One-Sided are available in packages of 3, 6 or 12 pcs

Indications

- Opening of the interdental contact points
- Widening of the interdental spaces in orthodontics by bilateral or unilateral tooth size reduction
- Elimination of minor crowding and treatment finishing in orthodontics
- Bilateral proximal enamel polishing

Benefits

- Efficient opening of the interdental contact points
- Rapid and controlled enamel reduction
- Proximal contouring, finishing and polishing of both adjacent teeth in a single procedure
- Reusable

Dr. Francesco Garino, Turin, Italy

Clinical pictures



- 01 Opening of the interdental space with OS08OP-DS, Opener, 8 µm
- 02 Contouring with OS40M-DS, Medium, 40 µm
- 03 Reduction with OS60C-DS, Coarse, 60 µm
- 04 High reduction of enamel with OS80XC-DS, Extracoarse, 80 µm
- 05 Controlled finishing with OS25F-DS, Fine, 25 µm
- 06 Polishing with OS15POL-DS, Polishing, 15 µm

Colour code	Micron	Description
524	80 µm	Extracoarse
524	60 µm	Coarse
514	40 µm	Medium
514	25 µm	Fine
504	15 µm	Polishing
494	8 µm	Opener

Diamond-coated:
DS = Double-Sided
L = Left
R = Right

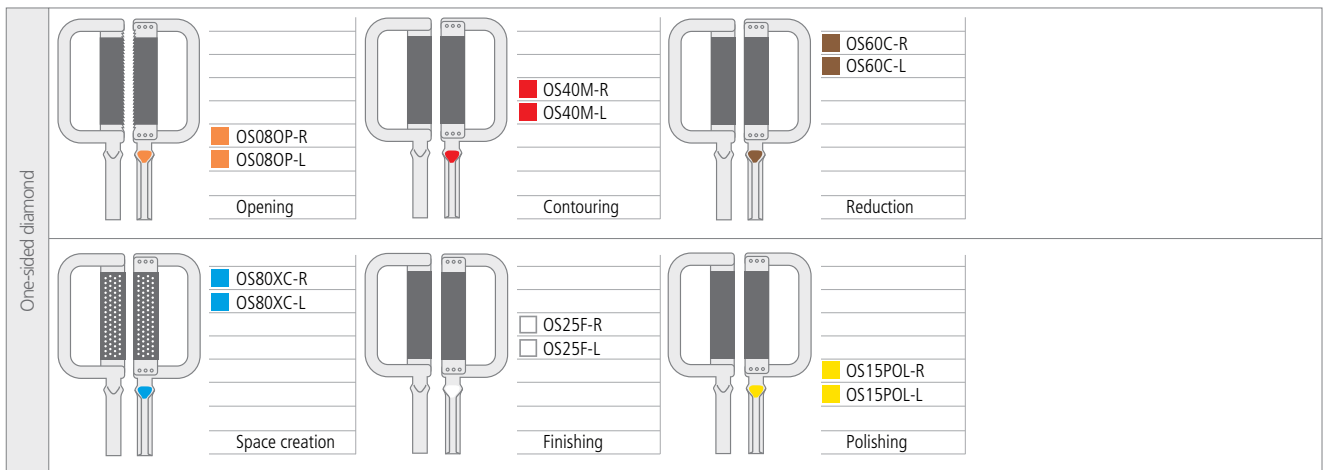
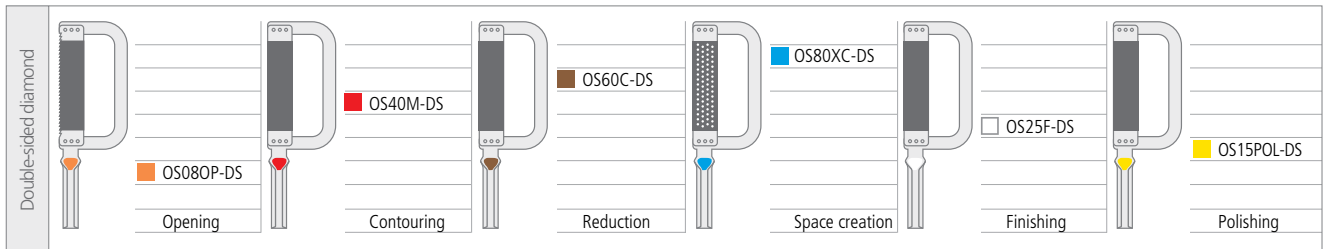

Intensiv Ortho-Strips System, Central Pat. EP15201863.6

Innovative oscillating strips,
with central diamond-coated operative area

Thanks to the diamond coating in the central operating area. Intensiv Ortho-Strips System, Central allows for high precision in the approximal reduction, finishing and polishing of enamel, respecting the original morphology and dental tissue. During the process of enamel reduction, trimming and polishing in orthodontics (stripping), parts of enamel or dentine below the tooth equator may be removed unintentionally, which may cause subsequent hypersensitivity of the tooth in the patient.



Product Description

- Oscillating strips, with diamond-coated operative central area
- 4 different grits:
 - 60 µm, brown, reduction
 - 40 µm, red, contouring
 - 25 µm, white, finishing
 - 15 µm, yellow, polishing
- Strip thickness of the not diamond-coated area: 0.05 mm
- Total height of strip: 3.7 mm
- Diamond area height: 2.7 mm
- Diamond area length: 13 mm
- Sterilizable

Intensiv Ortho-Strips System, Central, Double-Sided, are available in packages of 3 pcs:

REF OS60C-CEN-DS/3
REF OS40M-CEN-DS/3
REF OS25F-CEN-DS/3
REF OS15POL-CEN-DS/3

Or as Set of 6pcs each one article:
REF OSSetCEN02/6, Intensiv Ortho-Strips System OP, XC & 4 Central Double-Sided

Intensiv Ortho-Strips System, Central, One-Sided, are available in packages of 3 pcs:

REF OS60C-CEN-L/3
REF OS40M-CEN-L/3
REF OS25F-CEN-L/3
REF OS15POL-CEN-L/3
REF OS60C-CEN-R/3
REF OS40M-CEN-R/3
REF OS25F-CEN-R/3
REF OS15POL-CEN-R/3

Or as Set of 6pcs each one article, Left-Side or Right-Side:
REF OSSetCEN02L/6, Intensiv Ortho-Strips System OP, XC & Central Left-Sided
REF OSSetCEN02R/6, Intensiv Ortho-Strips System OP, XC & Central Right-Sided

Indications

- Reduction, finishing and polishing of proximal enamel in orthodontics

Benefits

- Easy introduction into the interdental contact points
- Prevention of cervical steps
- Dentine hypersensitivity would not be supported
- Conservation of the original morphology of the tooth equator
- Reusable

Dr. Francesco Garino, Turin, Italy

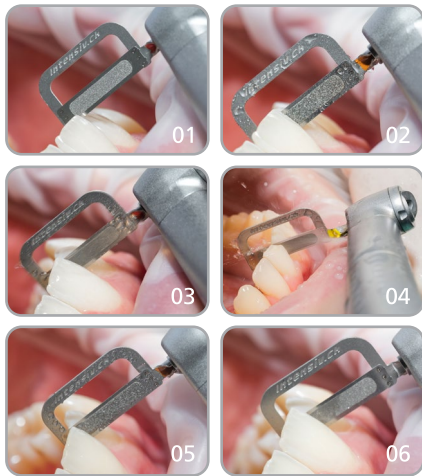

Cervical step

Respecting the original morphology and dental tissue

- 01 Easy introduction of the strip thanks to the diamond coating-free lower edge
- 02 Prevention of cervical steps thanks to the non-diamond coated lower edge of the strip
- 03 Enamel contouring with Intensiv Ortho-Strips System, Central, Medium, 40 µm
- 04 Enamel reduction with Intensiv Ortho-Strips System, Central, Coarse, 60 µm
- 05 Controlled finishing of the treated enamel with Intensiv Ortho-Strips System, Central, Fine, 25 µm
- 06 Polishing of the treated enamel with Intensiv Ortho-Strips System, Central, Polishing, 15 µm

Colour code	Micron	Description
524	60 µm	Coarse
514	40 µm	Medium
514	25 µm	Fine
504	15 µm	Polishing

Diamond-coated:
DS = Double-Sided
L = Left
R = Right



Double-sided diamond		OS40M-CEN-DS	Contouring
		OS60C-CEN-DS	Reduction
		OS25F-CEN-DS	Finishing
		OS15POL-CEN-DS	Polishing
One-sided diamond		OS40M-CEN-R OS40M-CEN-L	Contouring
		OS60C-CEN-R OS60C-CEN-L	Reduction
		OS25F-CEN-R OS25F-CEN-L	Finishing
		OS15POL-CEN-R OS15POL-CEN-L	Polishing

Intensiv OST400Set01/6

New

Set for Interproximal Reduction

Intensiv Ortho-Strips Tray 400 Set is for the aligner treatment and follows a IPR protocol.





It also contains the new, patented Intensiv Ortho-Strips System, Central. Thanks to the diamond coating in the central operating area, the Intensiv Ortho-Strips System, Central allows for high precision in the approximal reduction, finishing and polishing of enamel, respecting the original morphology and dental tissue.



Product Description

- 1 Intensiv Ortho-Strips Tray REF OST400
- 1 Intensiv Ortho-Strips System, Opener, REF OS08OP-DS
- 2 Intensiv Ortho-Strips System, Central, Medium, REF OS40M-CEN-DS
- 1 Intensiv Ortho-Strips System, Central, Coarse, REF OS60C-CEN-DS
- 1 Intensiv Ortho-Strips System, Central, Fine, REF OS25F-CEN-DS
- 1 Intensiv Ortho-Strips System, Central, Polishing, REF OS15POL-CEN-DS

REF OST400Set01/6

Colour code	Micron	Description
 524	60 µm	Coarse
 514	40 µm	Medium
 514	25 µm	Fine
 504	15 µm	Polishing
 494	8 µm	Opener

Diamond-coated:
DS = Double-Sided
L = Left
R = Right

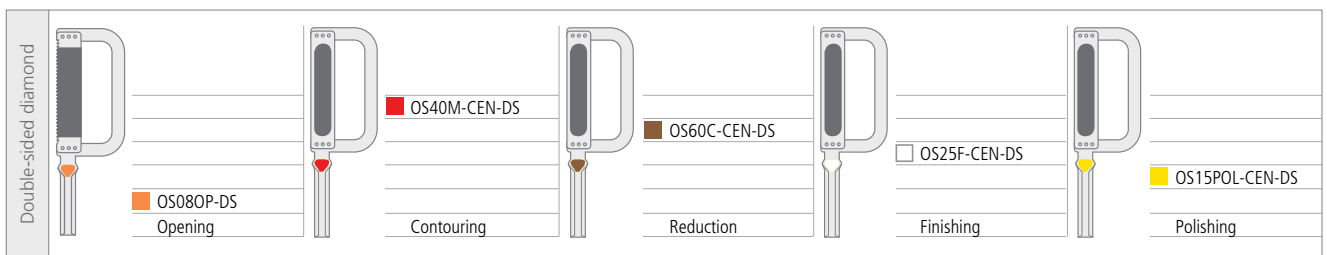

Indications

- Reduction, finishing and polishing of proximal enamel in orthodontics

Benefits

- Arrangement of Intensiv Ortho-Strips during Orthodontic stripping procedures
- Easy introduction into the interdental contact points
- Prevention of cervical steps
- Dentine hypersensitivity would not be supported

Intensiv ApproxOpener

Manual and serrated diamond coated metal strip for opening of tight contact points in Orthodontics

Indications

- Manual interproximal opening of tight contact points in orthodontic treatments (stripping)

Benefits

- Frictionless application between contact points thanks to ultra-fine grain size and serrated edge
- Calibrated opening for application of the stripping method
- Safe application due to arch tension

Dr. Francesco Garino, Turin, Italy

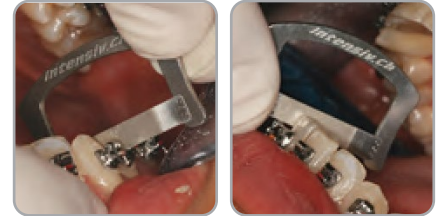

Product Description

Diamond coated manual metal strip clamped into a small metal bow; in 2 versions:

- Serrated and one-sided diamond coating (8µm), thickness approx. 0.09 mm
- Serrated and double-sided diamond coating (8µm), thickness approx. 0.10 mm
- Height of strip: 4 mm
- Length of strip: 20 mm



REF AO2018DS/3 Double Sided
REF AO2018OS/3 One Sided

Intensiv IPR-DistanceControl

Manual stainless steel instrument to support the control of tooth distances created during IPR protocols

Indications

- Support for the control of the teeth distance in the various stages of the IPR technique in orthodontics.

Benefits

- Secure application due to the handle
- Support thanks to the different thicknesses
- Large number of controls of distances, thanks to the combination of 8 instruments

Dr. Francesco Garino, Turin, Italy

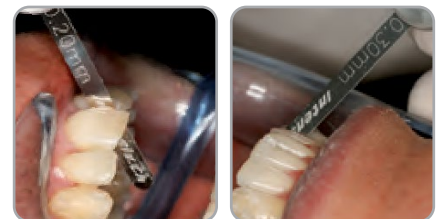

Product Description

- Intensiv IPR-DistanceControl is a manual metal instrument
- It consists of an eight-part instrument set made of stainless steel with grip (fingergrip)
- The thickness indication is marked on each instrument
- Removable plastic rivet to secure the 8 instruments
- Height / Length of metallic element (excl. grip): 4 / 40 mm

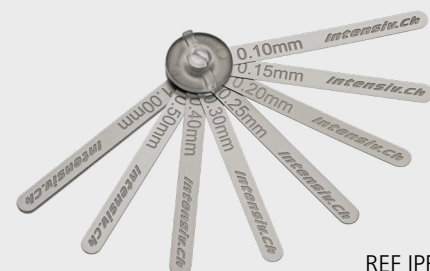

REF IPR-DC Set

Intensiv IPR Set

Calibrated and precise stripping (IPR) in orthodontics
Mechanical and manual strips in stainless steel tray

Stripping protocols in orthodontics (IPR = interproximal reduction) require a selection of mechanical or manual instruments for the opening of contact points, for enamel reduction and the finishing of proximal surfaces. The orthodontist needs efficient tools for stripping, which are ergonomically and practically arranged for the treatment of each patient.

Product Description

- Tray in polished stainless steel
- Dimensions: 190x100x25 mm (LxWxH)
- Compact arrangement of silicone inserts for holding the instruments in place, suitable for easy removal and safe replacement of the instruments in the tray
- Tray contains tools for mechanical and manual stripping in Orthodontics
- Strips and controlling instruments are inserted into two foldable internal supports, which display instrument reference numbers
- Supporting silicone inserts have the same colour code as the grit of the strips and may be replaced if needed
- Tray also available empty

Intensiv IPR Set
REF IPR 6000/WG-69 LT (Intensiv Swingle with light)
REF IPR 6000/WG-69 A (Intensiv Swingle without light)
REF IPR 6000 (empty Tray)

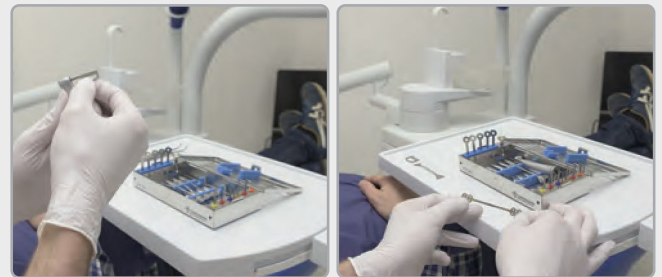
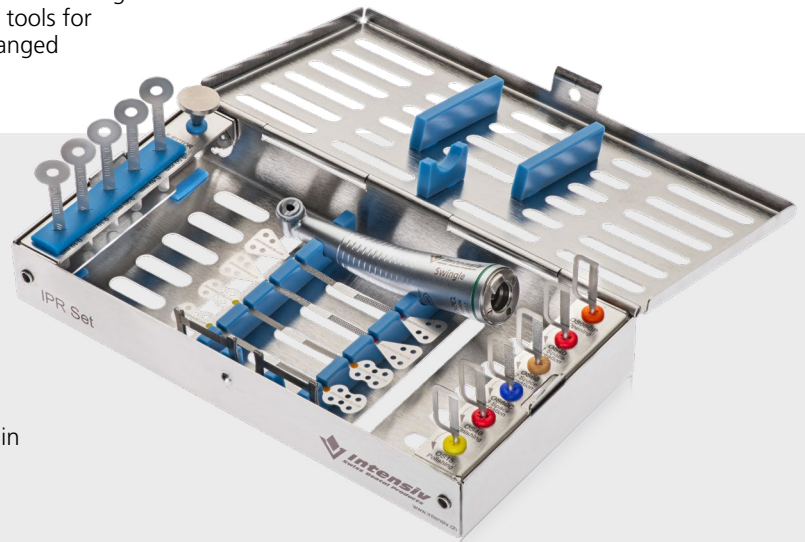

Indications

- Application for space creation during stripping procedures (IPR) in Orthodontics

Benefits

- All instruments required for interproximal reduction (IPR) composed together in a tray, placed and ready for use
- Indication of the specific grit sizes of the strips, instruments in sequence according to the application protocol
- Facilitated classifying of instruments

Clinical pictures

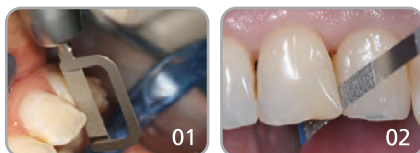

- 01 Efficient and controlled enamel reduction with Intensiv Ortho-Strips and Intensiv Swingle
- 02 Fast and efficient removal of excess material with Intensiv ProxoContour Coarse

Mechanical Stripping

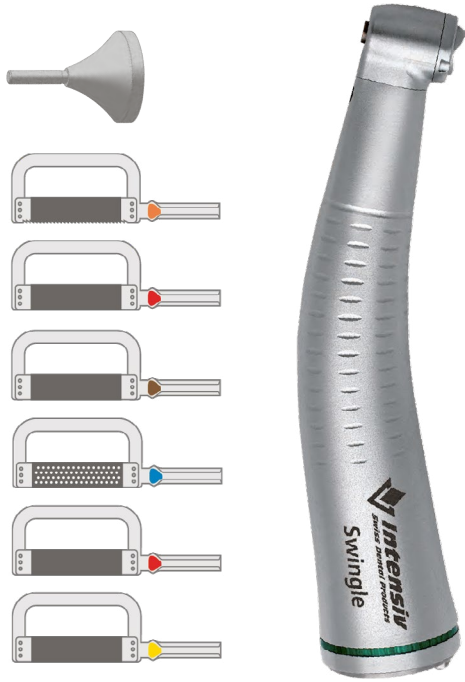

REF WG-69 LT *	Intensiv Swingle, reciprocating contra-angle (with light)
REF 053	Intensiv Ejector facilitates Strips removal during the various treatment steps
REF OS08OP-DS	Intensiv Ortho-Strips, 8 µm opener, serrated strip edge, for opening of contact points
REF OS40M-DS	Intensiv Ortho-Strips, 40 µm medium, for step one creating additional space
REF OS60C-DS	Intensiv Ortho-Strips, 60 µm coarse, for step two in creating additional space
REF OS80XC-DS	Intensiv Ortho-Strips, 80 µm extracoarse, perforated, for high enamel reduction
REF OS40M-DS	Intensiv Ortho-Strips, 40 µm medium, for pre-polishing of the grinded surfaces
REF OS15POL-DS	Intensiv Ortho-Strips, 15 µm polishing, for fine polishing of treated surfaces

* Contra-angle whitout light: REF WG-69 A

Control Instrument



REF IPR-DC010	IPR-DistanceControl, thickness 0.10 mm
REF IPR-DC015	IPR-DistanceControl, thickness 0.15 mm
REF IPR-DC020	IPR-DistanceControl, thickness 0.20 mm
REF IPR-DC040	IPR-DistanceControl, thickness 0.40 mm
REF IPR-DC050	IPR-DistanceControl, thickness 0.50 mm
1 Piece each	Manual tools for support for the control of the teeth distance

Manual Stripping

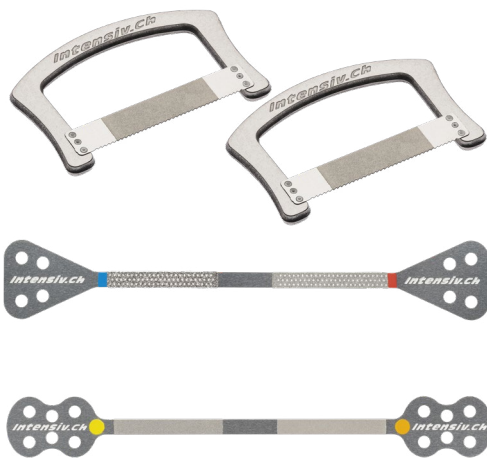

REF AO2018OS	Intensiv ApproxOpener 8 µm ultra-fine, one-sided diamond coating, serrated strip edge, for opening of contact points
REF AO2018DS	Intensiv ApproxOpener 8 µm, ultra-fine, double-sided diamond coating, serrated strip edge, for opening of contact points
REF PXCC8040	Intensiv ProxoContour Coarse, perforated, with two grit sizes, 80 µm coarse and 40 µm fine, for efficient, manual space creation
REF PXPO1508	Intensiv ProxoPolish, with two grit sizes, 15 µm extra-fine and 8 µm ultra-fine, for finishing and polishing of treated surfaces

Intensiv PrepTwins Pat. 2564803



Diamond Polymer Finisher
for refined shaping of all preparations

Finishing cavity and prosthetic edges is essential and preparatory to the subsequent steps. The removal of detached enamel prisms and irregular surfaces (so called wave structure) created by rotating instruments, allows an improvement and longer life span of intact restorations.



Product Description

- Diamond Polymer Finisher highly loaded in 3 different diamond grains
- The diamond grains are marked in the polymer by the colour brown (60 µm), red (40 µm) or yellow (15 µm)
- Forms: ball, cylinder, flame, football, torpedo, tapered cone
- Length: ball 2 mm, football 3.5 mm, cylinder 10 mm, flame and tapered cone 8 mm, torpedo 6 mm

Trial Kit, 60 µm - REF 2460/6
Trial Kit, 40 µm - REF 2440/6
Trial Kit, 15 µm - REF 2415/6

Intensiv PrepTwins are available in packages of 6 pieces

Colour code	Micron	Description
524	60µm	Medium
514	40µm	Fine
504	15µm	Extra fine

COLOUR CODE
Grit size indicator

DIAMETER
in ISO 1/10 mm

Form	Length (L)	Diameter (Ø)	Colour Code	Product Code
Ball	2.0	020	Brown	RA PT801/6
			Red	RA PT4801/6
			Yellow	RA PT5801/6
Football	3.5	020	Brown	RA PT368/6
			Red	RA PT4368/6
			Yellow	RA PT5368/6
Cylinder	10.0	020	Brown	RA PT882/6
			Red	RA PT4882/6
			Yellow	RA PT5882/6
Flame	8.0	020	Brown	RA PT862/6
			Red	RA PT4862/6
			Yellow	RA PT5862/6
Torpedo	8.0	020	Brown	RA PT847KR/6
			Red	RA PT4847KR/6
			Yellow	RA PT5847KR/6
Tapered cone	6.0	020	Brown	RA PT877K/6
			Red	RA PT4877K/6
			Yellow	RA PT5877K/6

Indications

- Finishing of the specific created preparation

Benefits

- Congruence between diamond polymer finisher and the shape of the diamond preparation instrument previously used
- Preserve specific created preparations
- Diamond coating on the metal core avoids metal signs on surface
- Selected grain in relation to the degree of shaping

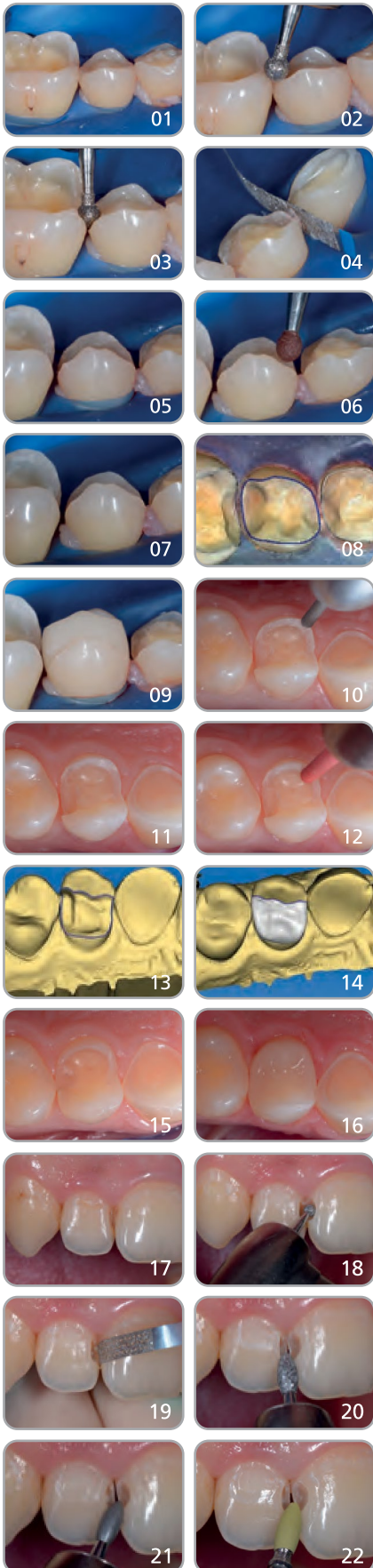

Posterior bite-raising

- 01 Initial clinical case: creation of the Table top on elements 44, 45 and 46 for the production of ceramic inlays with the CAD/CAM system
- 02 Lowering of the interproximal crown margins with the FG 301, 90 µm instrument
- 03 Deepening and mesial/distal opening of the interproximal space intended for positioning of the prosthetic device
- 04 Opening of proximal contacts, performed manually with Intensiv ProxoContour Coarse, characterized by 80 µm grit and two rows of perforations
- 05 Preparation completed
- 06 Advanced preparation of the edges conducted with Intensiv PrepTwins RA PT801, 60 µm, which allows for a distinctly improved optical image capture
- 07 Obvious improvement of the margins after being treated with the Finisher
- 08 Digital image that clearly shows the preparation margin
- 09 Edges are perfectly suited to the restoration

Bite-raising erosion

- 10 Creation of inlay on element 14: preparation of the edges with diamond-coated instrument FG 307L, 90 µm
- 11 Performed preparation, elimination of insufficient composite restoration in distal area
- 12 Advanced preparation with Intensiv PrepTwins RA PT4882, 40 µm
- 13 Optical impression highlighting the excellent margin preparation
- 14 Calculated digital image of the restoration
- 15 Evidence of the improvement of the preparation margins
- 16 Case concluded, cementing of the created inlay, ideal closure between dental tissue and restoration

Class III restoration

- 17 Initial case: Class III lesions on elements 12 and 11
- 18 Preparation of the two cavities with FG 201, 80 µm diamond-coated instrument
- 19 Removal of detached enamel prisms and opening of the edges adjacent to the lesions in the palatal direction
- 20 Beveling of the margins with FG 255, 90 µm diamond-coated instrument
- 21 Finishing of the margin with FG 4255, 40 µm diamond-coated instrument
- 22 Advanced preparation and elimination of the irregularities carried out with Intensiv PrepTwins RA PT5368, 15 µm: clear improvement of the state of the preparation margin

Intensiv ProxoStrip Pat. 699 819

A unique, diamond-coated metal strip with grips for the final polishing of proximal surfaces

Indications

- Finishing and polishing of fillings and crown borders in proximal areas
- Removal of excess material and overhangs in filling surfaces and crown borders

Benefits

- Finishing and polishing in one process
- Short strip for improved finger support (Hypomochlion) while stripping
- Clinically perfectly polished proximal surfaces

Dr. A. Devigus, Bülach, Switzerland



Product Description

- Metal strip, diamond-coated on one side only with two working parts of different grit size
- Perforated anatomical ends for a better gripping
- Sterilizable and reusable
- Total length: 80 mm | Height: 2.5 mm



REF PX4015/6, REF PX4015/12

■ 40 µm ■ 15 µm

Intensiv ProxoStrip Plus Pat. 699 819

A unique, diamond-coated metal strip with grips in plastic for the final polishing of proximal surfaces

Indications

- Finishing and polishing of fillings and crown borders in proximal areas
- Removal of excess material and overhangs in filling surfaces and crown borders

Benefits

- Finishing and polishing in one process
- Short strip for improved finger support
- Clinically perfectly polished proximal surfaces

Dr. A. Devigus, Bülach, Switzerland



Product Description

- Metal strip, diamond-coated on one side only with two working parts of different grit size
- Anatomical ends in sterilizable plastic for a better gripping
- Sterilizable and reusable
- Total length: 83 mm | Height: 2.5 mm



REF PXP4015/6, REF PXP4015/12

■ 40 µm ■ 15 µm

Intensiv ProxoStrip Anterior ^{Pat. 699 819}

The only short metal diamond-coated strip with grips for interproximal finishing of anterior restorations

Indications

- Finishing and polishing of fillings and crown borders in anterior proximal areas
- Removal of excess material and overhangs in filling surfaces and crown borders
- Beveling in adhesive restorations in the anterior proximal cervical areas

Benefits

- Finishing and polishing in one process
- Ergonomic grip for simple, safe use
- Short strip for improved finger support while stripping and shorter leverage with reduced distance to the operating area

Dr. A. Devigus, Bülach, Switzerland



Product Description

- Metal strip, diamond-coated on one side only with two working parts of different grit size
- Perforated anatomical ends for a better gripping
- Sterilizable and reusable
- Total length: 55 mm | Height: 2.5 mm



REF PXA4015/6, REF PXA4015/12 ■ 40 µm ■ 15 µm

Intensiv ProxoContour Coarse ^{Pat. 699 819}

Unique, diamond-coated metal strip for contouring and finishing

Indications

- Removal of marginal material excess of direct and indirect adhesive reconstructions
- Contouring and finishing of specific excess of pronounced aesthetic restorations

Benefits

- Friction-free application due to perforation of the diamond coated strip part
- Fast and efficient removal of excess material due to the coarse grain size

Dr. A. Devigus, Bülach, Switzerland



Product Description

- Metal strip, diamond-coated on one side only with two working parts of different grit size
- Perforated anatomical ends for a better gripping
- Sterilizable and reusable
- Total length: 80 mm | Height: 2.5 mm



REF PXCC8040/6 ■ 80 µm ■ 40 µm

Intensiv ProxoPolish

Pat. 699 819

Unique one-sided diamond-coated metal strip for efficient stain removal and manual polishing of proximal surfaces

Indications

- Stain removal in proximal areas
- Gloss polishing in proximal areas
- To complete the professional dental hygiene in the proximal zone

Benefits

- Efficient manual cleaning and polishing in one treatment process with the same instrument
- Ergonomic strip handles and short strip for simple and easy use

Dr. A. Devigus, Bülach, Switzerland



Product Description

- Metal strip, diamond-coated on one side only with two working parts of different grit size
- Perforated anatomical ends for a better gripping
- Sterilizable and reusable
- Total length: 80 mm | Height: 2.5 mm



REF PXPO1508/6

■ 15 µm ■ 8 µm

Intensiv Metal Diamond Strips Trial Kit

Contouring, Finishing and Polishing of aesthetical restorations in proximal surfaces

Intensiv ProxoStrip, Intensiv ProxoStrip Anterior, Intensiv ProxoContour Coars and Intensiv ProxoPolish Plus are unique diamond-coated metal strips. The length of the strips makes it easier to support the fingers during treatment. The strip height of 2.5mm and the free zone between the working areas maintain the existing contact point.

Product Description

- 4 different Metal strip, diamond-coated on one side only with two working parts
- Diamond-free zone between the diamond-coated surfaces
- Height: 2.5mm
- Thickness: 0.05 mm
- Sterilizable and reusable



Trial Kit REF PXT/6

Content:

- 2 Intensiv ProxoStrip
- 1 Intensiv ProxoStrip Anterior
- 2 Intensiv ProxoContour Coarse
- 1 Intensiv ProxoPolish

Intensiv UniglossPaste

Universal single step diamond high gloss polishing paste with micro-grain specifically adapted to the surface

Indications

- Final polishing and high gloss shining for composites

Benefits

- Can be used with either standard nylon bristle junior cup brush or Prophylaxis rubber cup
- High gloss polishing in only 15 seconds
- Same high gloss on restored and natural surfaces
- Only one paste for high gloss polishing

Dr. Simona Gianì, Varese, Italy



Product Description

- Polishing paste with a significant proportion of ultra-fine natural diamonds, adapted in its composition to the surface roughness of composites
- The selected mixture of diamond granules corresponds to the smallest dimensions of the ultrafine grits



REF 2500 - Syringe of 2.5g

Intensiv UniglossPolisher Pat.Pend.EP10162150.6

Shape-stable polymer diamond instrument for high polishing of aesthetic restorations

Indications

- Final high gloss polishing of all accentuated convex and concave surfaces of aesthetic restorations
- Maintenance of existing aesthetic restorations

Benefits

- Stable form of flame and cup shape through multiple use
- Superior gloss effect and minimal surface roughness
- Complete fissure polishing thanks to flexible but stable tip
- Protection of marginal closure of restorations

Dr. Simona Gianì, Varese, Italy

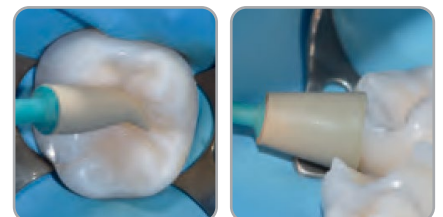

Product Description

- Diamond Polymer Polisher highly loaded with ultra-fine diamonds
- Slim flame and compact cup, uncoloured
- Inner core of flame and cup shape and mandrel consist of one piece of blue-green resistant polymer
- Sterilizable, reusable

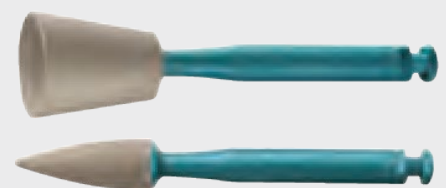

REF 2300/6 - Package of 3 pcs each
REF 2310/6 - 6 flames | REF 2320/6 - 6 cups

Specialities

Intensiv DiaTweezer

Tweezers with diamond-coated tips.
Polished surface.

Indications

- For gripping and securely holding small extraoral objects in dentistry e.g. a crown or an inlay/onlay

Benefits

- Firm and secure grip through the diamond-coated inner side of the instrument tips
- Secure hold of small hollow bodies with open tweezers through fully diamond-coated instrument tips



REF 1001



REF 1001A



REF 1002



REF 1002A



REF 1001: diamond-coating all around



REF 1002A: inside diamond-coating only

Intensiv ApproxOpener

Manual and serrated metal strip for removal
of coronal excess of adhesive aesthetic restorations

Indications

- Removal of emerged adhesive material in the coronal area

Benefits

- Removal of emerged adhesive material without scratches thanks to not diamond-coated version
- Secure strip movement thanks to tension of the strip in the bow
- Sterilisable, reusable

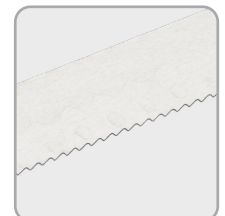

Product Description

- Manual metal strip clamped into a small metal bow
- Serrated
- Height of strip: 4 mm
- Length of strip: 20 mm



REF AO2018/3

Intensiv PerioDiaCurette

Diamond-coated periodontal curettes for manual smoothing of root surfaces

Indications

- Final root planing in periodontal therapy under unfavourable morphological conditions

Benefits

- The use of hand instruments ensures full tactile sensitivity
- Particularly suitable in case of concavities and grooves on the root surfaces
- Complete planing of the root surfaces up to homogeneity

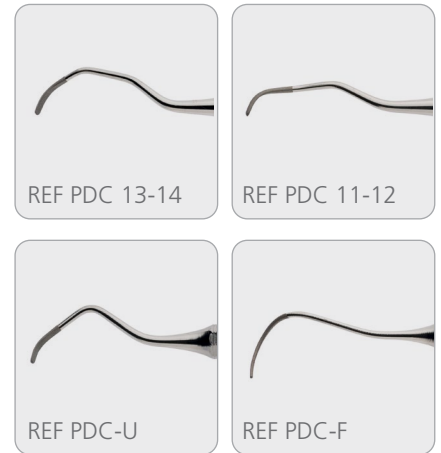

REF PDC 13-14
REF PDC-A (Assortment, 4 PerioDiaCurette)

Complementary products

INTENSIV DIAKLEEN

The rotating diamond instruments keep back remnants of enamel or other material during use. Therefore, they require regular cleaning and removal of these residues.



REF ACC060

INTENSIV MANDREL

For the application with polishing discs, a mandrel (type Moore) with a cross-shaped stainless steel head is used as a support for snap on discs.

- Stainless steel mandrel with crossshaped head for snap on discs
- Shank type RA
- Length: 25 mm
- Diameter: 2.35 mm
- Sterilizable



REF MRD22/6

INTENSIV UNIGRIP

Unigrip is a stainless metal reducer with a self-clamping chuck. Unigrip enables the use of FG Instruments in standard right-angle or handpiece.



REF 2002 W/6



REF 2003 H/6

Intensiv Laboratory Program

Diamond Instruments

First class Swiss Dental-Diamond-Instruments of highest quality and precision.
Instruments to be used with straight handpiece.
Please specify HP name before Ref. No.

Package content: 1 piece.
All forms shown on this page correspond to the actual size. The bold lines show the diamond coated side of the instrument.

REF	 Ø 012 1200	 Ø 019 1201	 L 1.5 Ø 016 1202	 L 4.0 Ø 014 1204	 L 5.0 Ø 015 1205	 L 4.0 Ø 012 1206		
REF	 Ø 026 1091	 Ø 035 1101	 Ø 046 1119	 L 2.0 Ø 025 1097	 L 3.0 Ø 032 1104	 L 1.0 Ø 025 1120A	 L 2.0 Ø 045 1120	 L 5.0 Ø 018 1114
REF	 L 5.5 Ø 024 1100	 L 7.0 Ø 043 1116*	* REF 1116 Also available with diamond coating on the top, REF DT1116					
REF	 L 6.5 Ø 022 1117	 L 7.0 Ø 037 1094	 L 9.5 Ø 051 1093	 L 6.5 Ø 020 1095	 L 8.5 Ø 017 1118	 L 6.5 Ø 026 1054	 L 11.0 Ø 027 1055	 L 9.0 Ø 040 1057
REF	 L 2.5 Ø 062 1011A							

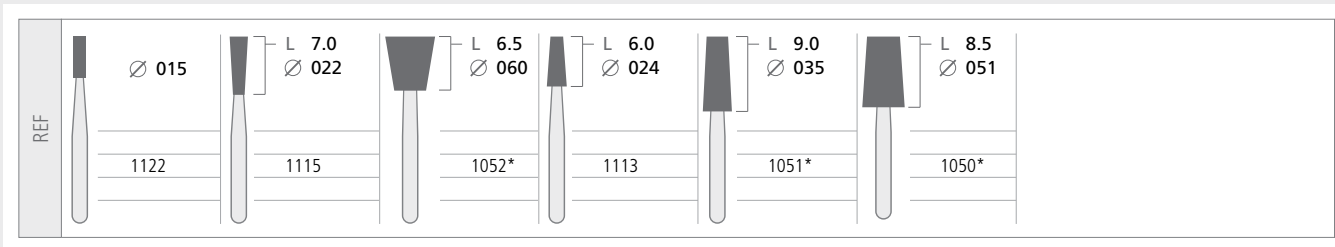

- * REF 1050 - Also available with diamond coating on the top, REF DT1050
- * REF 1051 - Also available with diamond coating on the top, REF DT1051
- * REF 1052 - Also available with diamond coating on the top, REF DT1052

Diamond Instruments

CONTINUED

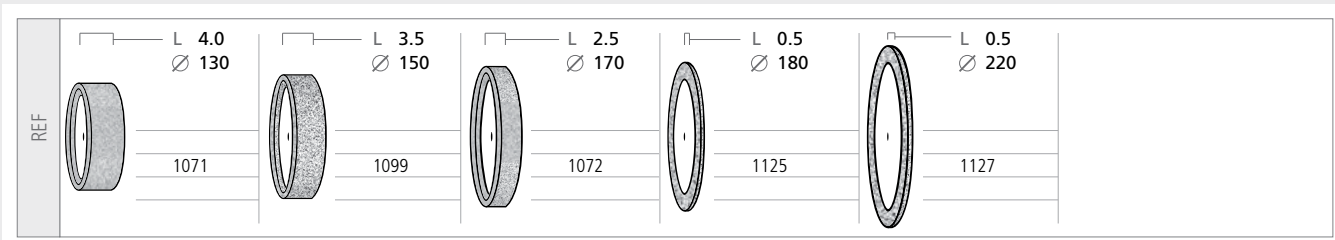
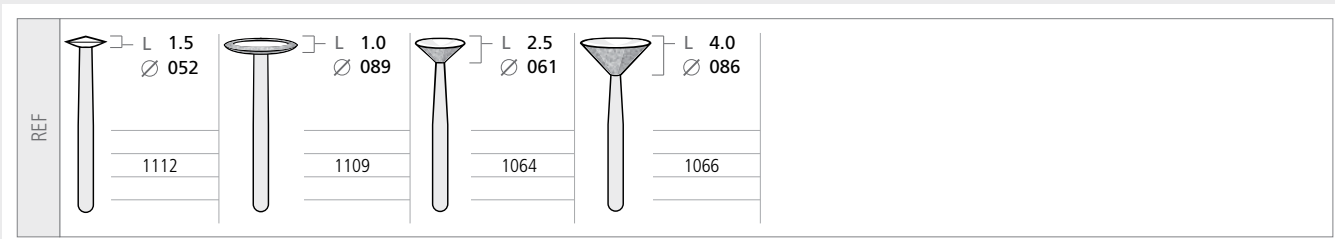

Separation Discs

SUPERFLEX

Flexible diamond discs with fine grit diamonds for ceramic and bridges.

All separation discs are available in both mounted and dismounted version. Package content: 1 piece

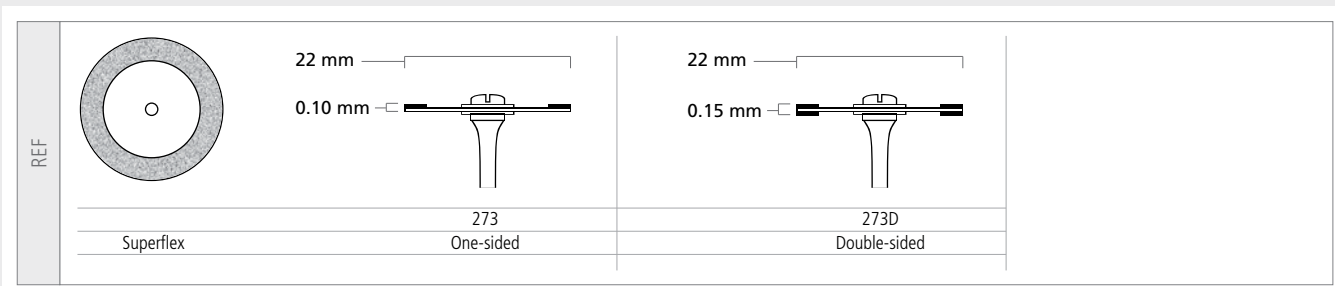
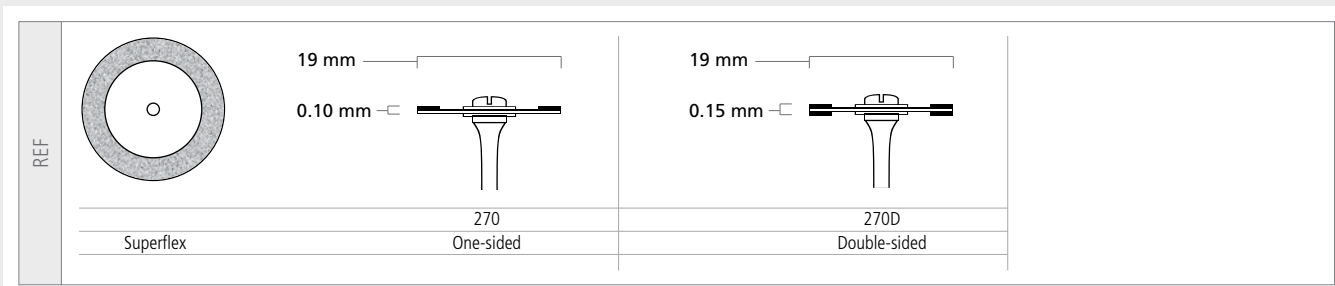

Index

Intensiv Sets

Conservative

■ Intensiv Cerinlay Set	6
■ Intensiv Minimal Invasiv Prep Set	7
■ Intensiv Composhape Set 1	8
■ Intensiv Composhape Set Anterior & Posterior	9
■ Intensiv Combi Prep Set: Direct Restauration	10
■ Intensiv Combi Prep Set: Controuring and Finishing Set	11
■ Intensiv Perio Set	12

Prosthetic

■ Intensiv Guided Universal Prep Set	14
■ Intensiv Sets Direct and Indirect Anterior & Posterior	16
■ Intensiv Advanced Prep & Finishing Set for Cerec Restorations	18
■ Intensiv Universal full Crown and Porcelain Veneer Prep Set	20
■ Intensiv Tooth Caring Bur Set	21
■ Intensiv Modular Veneer Set	22
■ Intensiv Geneva Prep Set	23
■ Intensiv ZirconCut Prosthetics	24

Shape chart Intensiv Diamond Instruments

26

Intensiv Diamond Instruments

■ Ball	28
■ Cone, inverted	30
■ Pear	32
■ Cylinder	34
■ Flame	41
■ Tapered	44
■ Torpedo	56
■ Football	60
■ Wheel	64
■ Lenticular	65
■ Special shapes	66

Intensiv Cutting Instruments

70

Trays

■ Intensiv HygienicTray	73
■ Intensiv ProxoshapeTray	74
■ Intensiv Ortho-StripsTray	75
■ Intensiv InstrumentTray	76
■ Intensiv IPR Tray	77

Oscillating Instruments

Contra-angle

- Intensiv Swingle 80
- Intensiv Swingle SWISS EDITION 82

Restoration

- Intensiv Proxoshape 84
- Intensiv Bevelshape 86

Instruments for orthodontics

Contra-angle

- Intensiv Swingle 90

Mechanical instruments

- Intensiv Ortho-Strips System 92
- Intensiv Ortho-Strips System, Central 94

Manual instruments

- Intensiv OST400Set01 96
- Intensiv ApproxOpener 97
- Intensiv IPR-DistanceControl 97

Finishing and Polishing

- Intensiv PrepTwins 100
- Intensiv ProxoStrip 102
- Intensiv ProxoStrip Plus 102
- Intensiv ProxoStrip Anterior 103
- Intensiv ProxoContour Coarse 103
- Intensiv ProxoPolish 104
- Intensiv Metall Diamantstreifen Trial Kit 104
- Intensiv UniglossPaste 105
- Intensiv UniglossPolisher 105

Specialities

- Intensiv DiaTweezer 106
- Intensiv PerioDiaCurette 106
- Intensiv ApproxOpener 107
- Complementary products: Intensiv Diakleen, Intensiv Mandrell, Intensiv Unigripp 107

Intensiv Laboratory Program

- Recommendations for Intensiv Diamond Instruments 112
- Intensiv table structure 113
- Intensiv code index 114

Recommendations for Intensiv Diamond Instruments

These general information and safety recommendations described here apply as guidelines for the Intensiv Diamond Instruments. A current version of the complete instructions for all products can be found at www.intensiv.ch

PRODUCT DESCRIPTION

- Stainless steel instruments with diamond coated working part
- Diamond grit-sizes: 8µm – 150µm
- Available in:
 - FG (Friction Grip) for turbine and red contra-angle
 - RA (Right Angle) for contra-angle
 - Spring shank (oscillating instruments) for reciprocating contra-angle.

INTENDED USE AND APPLICATION DETAILS

- Abrasion of enamel and dentin as well as dental materials for reducing, contouring, finishing and/or polishing in dentistry.
- Preparation and finishing of restorations in conservative dentistry and prosthodontics. The diamond-coated strips in particular can also be used in orthodontics.

INSTRUCTIONS FOR USE

- Application by authorised professionals such as dentists only.
- Before using the instruments, the qualified personnel should check on their own responsibility, whether the chosen instrument is suitable for the intended purpose.
- Insert instruments as deeply as possible into the chuck of the turbine or contra-angle. (Fig. 01). In the case of RA instruments, make sure that they are locked in place
- Set the handpiece at the required working speed (table below) before applying the instrument on the treated area.
- Activate water spray during the entire treatment (minimum 50 mL/min) for cooling and instruments cleaning. Ensure that there is consistent water flow.
- When using diamond instruments with a working part diameter larger than ISO 020 and longer than 10 mm and a diamond grit equal to or smaller than 50 microns, an additional cooling water supply is recommended.
- It is recommended to work under a rubber dam and to wear safety glasses as usual.
- Whenever clinically possible, use the entire length of the working part to allow for lower contact pressure and a uniform usage of the instrument (Fig. 02).
- Once the preparation has been completed, remove the instrument from the treated area and bring it to a standstill.

MAINTENANCE AND STERILIZATION

- All Intensiv instruments are supplied non-sterile. They must be disinfected and sterilised before the first and after each use on the patient.
- Pre-clean by disinfection the instruments immediately after each usage.
- After each application on the patient, clean the instruments and remove any deposits (soft brushes, cleaning rubber Intensiv Diakleen or/and ultrasound) to maintain the abrasive performance.



- Use cleaning and disinfection solutions strictly observing the concentrations and reaction times indicated by the manufacturer.
- In case of the presence of grinding residues on the instruments it is advisable to use an ultrasonic bath, cleaning rubber Intensiv Diakleen and/or soft brush for cleaning.
- After disinfection and cleaning, inspect the instruments for residues. If necessary, repeat the disinfection/cleaning procedure.
- Visual inspection for possible damage. Disposal of oxidised, eccentric or deformed instruments and instruments with completely or partially missing diamond coating.
- Cleaning and disinfection can be also carried out using professional thermodisinfectors.
- In principle, only sufficiently device- and product-specific validated procedures should be used for cleaning/disinfection and sterilisation.
- Full cleaning, disinfection, sterilization, checking and maintenance instructions can be requested at info@intensiv.ch

RISK WARNINGS

- Levering and tilting, excessive speed or contact pressure (table below) of rotating and oscillating instruments must be avoided as this increases the risk of instrument breakage.
- Never exceed the specified maximum speed, to avoid in rotating instruments breakage caused by the generation of powerful centrifugal forces. This occurs in particular when the diameter of the working part exceeds that of the shank (Fig. 03).
- Too much loss of the specific diamond coating can lead to local overheating when using these instruments due to insufficient abrasion.
- Avoid applying forces greater than the recommended values, as this may cause damage to the treated area as well as damage to the instrument.
- When instruments with fine grit size diamonds are used and the speed/pressure is too high, the treated zone may overheat due to insufficient abrasion.
- The use of instruments with diamonds that are too coarse in relation to the treatment target can lead to overtreatment.
- In order to guarantee the traceability of the instruments, it is necessary to keep the packaging with lot number during the entire period of use of the instruments.

Rotating Instruments FG

ISO Ø 1/10 mm	Speed min. -1 Speed range with water spray minimum 50 ml/min.	Grit 8-50 µm	Grit 60-106 µm	Grit 125-150 µm
006	Max 150.000	Contact pressure as light as possible, recommended load max 10g	Contact pressure as light as possible, recommended load max 20g	Contact pressure as light as possible, recommended load max 40g
↓	↓	↓	↓	↓
055	Max 20.000	Contact pressure as light as possible, recommended load max 50g	Contact pressure as light as possible, recommended load max 80g	Contact pressure as light as possible, recommended load max 160g

Rotating Instruments RA

ISO Ø 1/10 mm	Speed min. -1 Speed range with water spray minimum 50 ml/min.	Grit 8-50 µm	Grit 60-106 µm	Grit 125-150 µm
007	Max 40.000	Contact pressure as light as possible, recommended load max 10g	Contact pressure as light as possible, recommended load max 20g	Contact pressure as light as possible, recommended load max 40g
↓		↓	↓	↓
036		Contact pressure as light as possible, recommended load max 45g	Contact pressure as light as possible, recommended load max 70g	Contact pressure as light as possible, recommended load max 145g

Oscillating instruments - files and strips

Instrument	Speed min. -1 Speed range with water spray minimum 50 ml/min.	Grit 8-125 µm
Proxoshape	Speed range with water spray min. 50 ml/min.	Contact pressure as light as possible, recommended load max 50g
Ortho-Strips	Max 40'000 RPM, contra-angle green ring, 2:1, 20'000 oscillating movements/minute	Contact pressure as light as possible, recommended load max 100g

Intensiv table structure

Intensiv article numbers and colour coding of the grit size

Colour code	Micron		Description
544	150 µm	125 µm	Super coarse
534	125 µm	106 µm*	Coarse
524	106 µm	60/80/90 µm*	Standard
524	80 µm		Medium
524	60 µm		Medium
514	50 µm		Golden Burs GB
514	40 µm		Fine
514	25 µm		Fine
504	15 µm		Extra fine
494	8 µm		Ultra fine

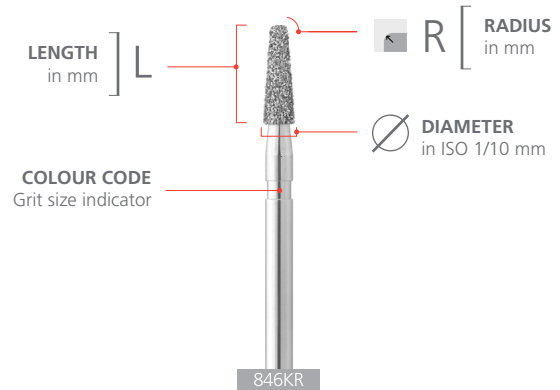

*Depending on the shape and size of the instruments, the grit size may differ from the specified value.

TAPERED 846KR • Rounded edge



FG • ISO 314	R 0.28 L 6.0 ∅ 012	R 0.28 L 6.0 ∅ 014	R 0.20 L 6.0 ∅ 014	R 0.28 L 6.0 ∅ 014	R 0.20 L 6.0 ∅ 015	R 0.28 L 6.0 ∅ 015	R 0.20 L 6.0 ∅ 016	RA • ISO 204
	FG 1040	FG 3425	FG 5417R	FG 8425	FG 4417R	FG 425CB	FG 417RC FG 417R FG 8417R	

Intensiv article number

Shank type

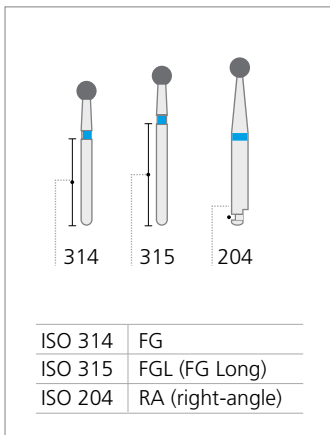

Definition of the shape

The tables are divided into shape groups: ball, inverted cone, pear, cylinder, flame, cone, torpedo, football, wheel, lenticular, special shapes. See shapes chart on pages 27-28

Symbols of indications

	Cavity preparation		Crown separation		Prophylaxis
	Amalgam removal		Crown preparation		Orthodontics
	Root planing		Finishing of the filling		

Intensiv code index

FG

Intensiv Code	Shape	Page	Intensiv Code	Shape	Page	Intensiv Code	Shape	Page	Intensiv Code	Shape	Page	Intensiv Code	Shape	Page	Intensiv Code	Shape	Page
FG 01125	839	66	FG 115 CB	807	31	FG 17L C	857	48	FG 200N GB	801	28	FG 214 GB	835	34	FG 233 C	850	51
FG 01140	839	66	FG 115 GB	807	31	FG 18	851	48	FG 200S	801	28	FG 215	807	31	FG 233 CB	850	51
FG 01425	839	66	FG 115A	836	69	FG 18 C	851	48	FG 200S GB	801	28	FG 215 C	807	31	FG 233 GB	850	51
FG 01440	839	66	FG 115A C	836	69	FG 18 GB	851	48	FG 201	801	28	FG 215 GB	807	31	FG 234	850	51
FG 01480	839	66	FG 116	847	45	FG 181	878K	59	FG 201 C	801	28	FG 215S	807	31	FG 234 C	850	51
FG 101	898	59	FG 116 C	847	45	FG 181 C	878K	59	FG 201 CB	801	28	FG 215S C	807	31	FG 234 CB	850	51
FG 101 C	898	59	FG 116 CB	847	45	FG 181 CB	878K	59	FG 201 GB	801	28	FG 215S GB	807	31	FG 234 GB	850	51
FG 101 CB	898	59	FG 116 GB	847	45	FG 181 GB	878K	59	FG 201L	801L	29	FG 216	805	30	FG 235	856	50
FG 101 GB	898	59	FG 116A	847	45	FG 181N	878K	59	FG 201N	801	28	FG 216 C	805	30	FG 235 C	856	50
FG 102	825	65	FG 116N	847	45	FG 181N C	878K	59	FG 201N C	801	28	FG 216 GB	805	30	FG 235 CB	856	50
FG 102 C	825	65	FG 116N C	847	45	FG 182	878K	59	FG 201N CB	801	28	FG 216A	805	30	FG 235 GB	856	50
FG 102 GB	825	65	FG 117	847	45	FG 182 C	878K	59	FG 201N GB	801	28	FG 216B	830	32	FG 235A	856	50
FG 102A C	818	64	FG 117 C	847	45	FG 182 CB	878K	59	FG 201NL	801L	29	FG 216N	805	30	FG 235A C	856	50
FG 102L	898	59	FG 117 CB	847	45	FG 182 GB	878K	59	FG 201NL C	801L	29	FG 216N C	805	30	FG 235S	856	50
FG 102L C	898	59	FG 117 GB	847	45	FG 183	878K	59	FG 2015	801	29	FG 216N GB	805	30	FG 235S C	856	50
FG 102L GB	898	59	FG 117A	852	52	FG 183 C	878K	59	FG 2015 C	801	28	FG 216S	805	30	FG 235S CB	856	50
FG 103	898	59	FG 117A C	852	52	FG 183 GB	878K	59	FG 2015 CB	801	28	FG 216S C	805	30	FG 236	850	51
FG 103 C	898	59	FG 117N	847	45	FG 184	878K	59	FG 2015 GB	801	28	FG 216S GB	805	30	FG 236 C	850	51
FG 103 GB	898	59	FG 117N C	847	45	FG 184 C	878K	59	FG 202	805	30	FG 217	805	30	FG 236 CB	850	51
FG 103A C	818	64	FG 117N GB	847	45	FG 184 CB	878K	59	FG 202 C	805	30	FG 217 C	805	30	FG 236 GB	850	51
FG 104	898	59	FG 117S	852	52	FG 184 GB	878K	59	FG 202 CB	805	30	FG 217 GB	805	30	FG 237	850	51
FG 104 C	898	59	FG 117S C	852	52	FG 185	878K	59	FG 202 GB	805	30	FG 217B	830	32	FG 237 C	850	51
FG 104 GB	898	59	FG 117S CB	852	52	FG 185 C	878K	59	FG 203L	801L	29	FG 217S	805	30	FG 237 CB	850	51
FG 1040	846KR	46	FG 117S GB	852	52	FG 185 CB	878K	59	FG 203L C	801L	29	FG 217S C	805	30	FG 237 GB	850	51
FG 106	846	44	FG 118	807	31	FG 185 GB	878K	59	FG 204	835	34	FG 217S GB	805	30	FG 237L	856L	50
FG 106 C	846	44	FG 119	807	31	FG 189	801	28	FG 204 C	835	34	FG 218	830R	32	FG 237L C	856L	50
FG 106 CB	846	44	FG 119 C	807	31	FG 18L	857	48	FG 204 CB	835	34	FG 218 C	830R	32	FG 238	850	51
FG 107A	846	44	FG 119A	807	31	FG 18L C	857	48	FG 204 GB	835	34	FG 218 CB	830R	32	FG 238 C	850	51
FG 107A C	846	44	FG 119A C	807	31	FG 18L GB	857	48	FG 204L	801L	29	FG 218 GB	830R	32	FG 238 CB	850	51
FG 108A C	818	64	FG 11A	909	64	FG 19	851	48	FG 204L C	801L	29	FG 218B	830	32	FG 238 GB	850	51
FG 109	846	44	FG 11A C	909	64	FG 19 C	851	48	FG 205	860	41	FG 219	830R	32	FG 238L	856L	50
FG 109 C	846	44	FG 11A CB	909	64	FG 19 GB	851	48	FG 205 C	860	41	FG 219 C	830R	32	FG 238L C	856L	50
FG 109 CB	846	44	FG 11A GB	909	64	FG 190	879K	59	FG 205 CB	860	41	FG 219 CB	830R	32	FG 239L	856L	50
FG 109A	846	44	FG 123	886Z	55	FG 190 C	879K	59	FG 205 GB	860	41	FG 219 GB	830R	32	FG 239L C	856L	50
FG 109A C	846	44	FG 123 C	886Z	55	FG 191	879K	59	FG 205A	845	44	FG 219B	830	32	FG 240	850L	51
FG 10A	909	64	FG 123 GB	886Z	55	FG 191 C	879K	59	FG 205L	861	41	FG 219N	830R	32	FG 240 C	850L	51
FG 10A C	909	64	FG 124	885	40	FG 191 CB	879K	59	FG 205L C	861	41	FG 219N C	830R	32	FG 240 CB	850L	51
FG 10A GB	909	64	FG 124 C	885	40	FG 191 GB	879K	59	FG 205L CB	861	41	FG 219N CB	830R	32	FG 240 GB	850L	51
FG 110	818	64	FG 124 CB	885	40	FG 192	879K	59	FG 205L GB	861	41	FG 220	830R	32	FG 240L	856L	50
FG 110 C	818	64	FG 124 GB	885	40	FG 192 C	879K	59	FG 205S	860	41	FG 220 C	830R	32	FG 240L C	856L	50
FG 111	818	64	FG 124L	886	40	FG 192 CB	879K	59	FG 205S C	860	41	FG 220 CB	830R	32	FG 241	811L	63
FG 111 C	818	64	FG 124L C	886	40	FG 192 GB	879K	59	FG 206	845	44	FG 220 GB	830R	32	FG 241 C	811L	63
FG 111 GB	818	64	FG 124L CB	886	40	FG 193	879K	59	FG 206 C	845	44	FG 220B	830	32	FG 241 CB	811L	63
FG 111A	818	64	FG 124L GB	886	40	FG 193 C	879K	59	FG 206 CB	845	44	FG 220S	830R	32	FG 241 GB	811L	63
FG 111A C	818	64	FG 125	885	40	FG 193 CB	879K	59	FG 206 GB	845	44	FG 220S C	830R	32	FG 243	899	63
FG 113	846	44	FG 125 C	885	40	FG 193 GB	879K	59	FG 206A	845	44	FG 221B	830	32	FG 243 C	899	63
FG 113 C	846	44	FG 130	815	64	FG 194	879K	59	FG 207	807	31	FG 223	830RL	33	FG 243 GB	899	63
FG 113 CB	846	44	FG 131	885	40	FG 194 C	879K	59	FG 208	845	44	FG 223 C	830RL	33	FG 244	835	34
FG 113 GB	846	44	FG 133	885	40	FG 194 CB	879K	59	FG 208 C	845	44	FG 223 CB	830RL	33	FG 244 C	835	34
FG 113A	852	52	FG 134	885	40	FG 195	879K	59	FG 208 CB	845	44	FG 223 GB	830RL	33	FG 244 CB	835	34
FG 113A C	852	52	FG 134 C	885	40	FG 196	879K	59	FG 208 GB	845	44	FG 223B	830L	32	FG 244A	835	34
FG 113A CB	852	52	FG 136	885	40	FG 196 C	879K	59	FG 210	835	34	FG 224	830RL	33	FG 244A C	835	34
FG 113A GB	852	52	FG 136 C	885	40	FG 196L	801L	29	FG 210 C	835	34	FG 224 C	830RL	33	FG 245	899	63
FG 113N	847	45	FG 161	877K	58	FG 197	811	63	FG 210 CB	835	34	FG 224 GB	830RL	33	FG 245 C	899	63
FG 113N C	847	45	FG 161 C	877K	58	FG 197 C	811	63	FG 210 GB	835	34	FG 225	830RL	33	FG 245 GB	899	63
FG 113N CB	847	45	FG 161 GB	877K	58	FG 198	811	63	FG 211	835	34	FG 225 C	830RL	33	FG 246	850L	51
FG 113N GB	847	45	FG 161N	877K	58	FG 198 C	811	63	FG 211 C	835	34	FG 225 CB	830RL	33	FG 246 C	850L	51
FG 113NR	847KR	47	FG 161N C	877K	58	FG 198 CB	811	63	FG 211S	835	34	FG 225 GB	830RL	33	FG 247	850L	51
FG 113S	847	45	FG 162	877K	58	FG 198 GB	811	63	FG 212	835	34	FG 226	830RL	33	FG 247 C	850L	51
FG 113S C	847	45	FG 162 C	877K	58	FG 198A	811	63	FG 212 C	835	34	FG 226 C	830RL	33	FG 247 GB	850L	51
FG 113S CB	847	45	FG 162 CB	877K	58	FG 198A C	811	63	FG 212 CB	835	34	FG 227	830RL	33	FG 248	850L	51
FG 113S GB	847	45	FG 162 GB	877K	58	FG 198A CB	811	63	FG 212 GB	835	34	FG 227 C	830RL	33	FG 248 C	850L	51
FG 114	836	35	FG 163	877K	58	FG 199	801	28	FG 212S	835	34	FG 227 CB	830RL	33	FG 249	850L	51
FG 114 C	836	35	FG 163 C	877K	58	FG 19A	851	48	FG 212S CB	835	34	FG 228	845	44	FG 249 C	850L	51
FG 114 CB	836	35	FG 163 CB	877K	58	FG 19A GB	851	48	FG 212S GB	835	34	FG 228 C	845	44	FG 250	379	62
FG 114 GB	836	35	FG 163 GB	877K	58	FG 19L	857	48	FG 213	846	44	FG 229	830L	33	FG 250 C	379	62
FG 114A	836	35	FG 164	877K	58	FG 19L C	857	48	FG 213 C	846	44	FG 229 C	830L	33	FG 250 CB	379	62
FG 114A C	836	35	FG 164 C	877K	58	FG 200	801	28	FG 213 CB	846	44	FG 230	830L	33	FG 250 GB	379	62
FG 114S	836	35	FG 16L	857	48	FG 200 C	801	28	FG 213 GB	846	44	FG 230 C	830L	33	FG 250A	379	62
FG 114S C	836	35	FG 16L C	857	48	FG 200 GB	801	28	FG 214	835	34	FG 231	850	51	FG 250A C	379	62
FG 115	807	31	FG 17	851	48	FG 200L	801L	29	FG 214 C	835	34	FG 232	850	51	FG 250A GB	379	62
FG 115 C	807	31	FG 17L	857	48	FG 200N	801	28	FG 214 CB	835	34	FG 233	850	51	FG 252	368	60

Intensiv Code	Shape	Page	Intensiv Code	Shape	Page	Intensiv Code	Shape	Page	Intensiv Code	Shape	Page	Intensiv Code	Shape	Page	Intensiv Code	Shape	Page
FG 252A	368	60	FG 301 C	802	29	FG 30D2	858	52	FG 316N GB	806	30	FG 3405L	863	43	FG 401 CB	801	28
FG 253	368	60	FG 301 CB	802	29	FG 30D3	859	53	FG 316S	806	30	FG 3408	878	57	FG 401 GB	801	28
FG 253 C	368	60	FG 301A	802	29	FG 30D34	859	53	FG 316S C	806	30	FG 3409R	845KR	46	FG 4011A	909	64
FG 254	368	60	FG 301A C	802	29	FG 30D4	859	53	FG 316S GB	806	30	FG 341	822	32	FG 402	805	30
FG 254 C	368	60	FG 301S	802	29	FG 30D6	850	51	FG 317L	837L	35	FG 3410	879	57	FG 402 C	805	30
FG 254A GB	368	60	FG 301S C	802	29	FG 30D8	855	49	FG 317L C	837L	35	FG 3413	845	44	FG 402 CB	805	30
FG 255	368	60	FG 301S GB	802	29	FG 310	879	57	FG 317L CB	837L	35	FG 3413R	845KR	46	FG 402 GB	805	30
FG 255 C	368	60	FG 302	806	30	FG 310 C	879	57	FG 317L GB	837L	35	FG 3414	836KR	36	FG 4035	833	66
FG 255 CB	368	60	FG 302 C	806	30	FG 310 CB	879	57	FG 3200	801	28	FG 3414B	836KR	36	FG 4036	837	35
FG 255 GB	368	60	FG 302 CB	806	30	FG 310 GB	879	57	FG 3200S	801	28	FG 342	822	32	FG 4037	879	57
FG 255A	368	60	FG 302 GB	806	30	FG 311	862	42	FG 3201	801	28	FG 3422	847KR	47	FG 4038	882	39
FG 255A C	368	60	FG 302A	802	30	FG 311 C	862	42	FG 3205	860	41	FG 3425	846KR	46	FG 404	838	38
FG 255A GB	368	60	FG 302A C	802	29	FG 311 CB	862	42	FG 3205L	861	41	FG 3427	847KR	47	FG 404 C	838	38
FG 256	379	61	FG 303	813	31	FG 311 GB	862	42	FG 3206	845	44	FG 343	822	32	FG 404 CB	838	38
FG 256 C	379	61	FG 303 C	813	31	FG 3113NR	847KR	47	FG 321	881	39	FG 343 C	822	32	FG 404 GB	838	38
FG 256 GB	379	61	FG 303 CB	813	31	FG 3113R	846KR	46	FG 321 C	881	39	FG 3510	836KR	36	FG 4040B	879	57
FG 257	379	61	FG 303A	813	31	FG 3113S	847	45	FG 3210	835	34	FG 3513	846KR	46	FG 404L	863	43
FG 257 C	379	61	FG 303A C	813	31	FG 3116	847	45	FG 3211S	835	34	FG 3513N	847KR	47	FG 405L	863	43
FG 257 CB	379	61	FG 303S	813	31	FG 3117	847	45	FG 3212S	835	34	FG 3514	836KR	36	FG 405L C	863	43
FG 257 GB	379	61	FG 303S C	813	31	FG 3117N	847	45	FG 3214	835	34	FG 3517	847KR	47	FG 405L GB	863	43
FG 257S	379	61	FG 304	835	34	FG 311S	862	42	FG 3218	830	32	FG 3525	846KR	46	FG 406	877	56
FG 257S C	379	61	FG 304 C	835	34	FG 311S C	862	42	FG 3219	830	32	FG 3526	847KR	47	FG 406 C	877	56
FG 257S GB	379	61	FG 304 CB	835	34	FG 312	862	42	FG 322	881	39	FG 360	858	52	FG 406 GB	877	56
FG 258	379	61	FG 304 GB	835	34	FG 312 C	862	42	FG 322 C	881	39	FG 360 C	858	52	FG 4062	877K	58
FG 258 C	379	61	FG 3040B	879	57	FG 312 CB	862	42	FG 3223	830L	33	FG 361	858	52	FG 407R	845KR	46
FG 258 CB	379	61	FG 3040SB	879	57	FG 312 GB	862	42	FG 3224	830L	33	FG 361 C	858	52	FG 407R C	845KR	46
FG 258 GB	379	61	FG 305	880	38	FG 3124L	886	40	FG 3225	830L	33	FG 3614	837KR	37	FG 407R GB	845KR	46
FG 258N	379	61	FG 305 C	880	38	FG 312L	837L	35	FG 3233	850	51	FG 3614B	837KR	37	FG 408	878	57
FG 258N C	379	61	FG 305 CB	880	38	FG 312N	863	43	FG 3235	856	50	FG 363	862	42	FG 408 C	878	57
FG 258N GB	379	61	FG 305 GB	880	38	FG 312N C	863	43	FG 3236	850	51	FG 364	862	42	FG 408 CB	878	57
FG 259	379	61	FG 305L	882	39	FG 312N CB	863	43	FG 3237	850	51	FG 364 C	862	42	FG 408 GB	878	57
FG 259 C	379	61	FG 305L C	882	39	FG 312N GB	863	43	FG 324	881	39	FG 365	862	42	FG 409R	845KR	46
FG 259 CB	379	61	FG 305L CB	882	39	FG 313	845	44	FG 324 C	881	39	FG 365 C	862	42	FG 409R C	845KR	46
FG 259 GB	379	61	FG 305L GB	882	39	FG 313 C	845	44	FG 3240	850L	51	FG 366	877	56	FG 409R GB	845KR	46
FG 260	379	61	FG 305LP C	837KR	37	FG 313A	837	35	FG 3243	899	63	FG 366 C	877	56	FG 40D1	956	54
FG 260 C	379	61	FG 305S	880	38	FG 313A C	837	35	FG 325	881	39	FG 366 CB	877	56	FG 40D14	858	52
FG 261	835KR	36	FG 305S C	880	38	FG 313L	837L	35	FG 325 C	881	39	FG 366 GB	877	56	FG 40D16	855	49
FG 262	835KR	36	FG 305S CB	880	38	FG 313L C	837L	35	FG 325 CB	881	39	FG 367	862	42	FG 40D17	855	49
FG 263	835KR	36	FG 305S GB	880	38	FG 314	837	35	FG 325 GB	881	39	FG 367 C	862	42	FG 40D18	856	50
FG 263 C	835KR	36	FG 306	877	56	FG 314 C	837	35	FG 3250	379	62	FG 370	369	61	FG 40D2	858	52
FG 264	835KR	36	FG 306 C	877	56	FG 314 CB	837	35	FG 3255	368	60	FG 370 C	369	61	FG 40D21	888	43
FG 264 C	835KR	36	FG 306 GB	877	56	FG 314 GB	837	35	FG 3256	379	61	FG 3710B	836KR	36	FG 40D25	856	50
FG 265	835KR	36	FG 306A	877	56	FG 314A	837	35	FG 3257	379	61	FG 3712B	837KR	37	FG 40D26	856	50
FG 265 C	835KR	36	FG 306S	876	56	FG 314L	837L	35	FG 3258	379	61	FG 3714B	836KR	36	FG 40D3	859	53
FG 266	835KR	36	FG 306S C	876	56	FG 314L C	837L	35	FG 3259	379	61	FG 378	863	43	FG 40D34	859	53
FG 266 C	835KR	36	FG 306S GB	876	56	FG 314L CB	837L	35	FG 326	837KR	37	FG 378 C	863	43	FG 40D4	859	53
FG 268	379	61	FG 307	881	39	FG 314L GB	837L	35	FG 326 C	837KR	37	FG 388	878	57	FG 40D5	848	45
FG 268 C	379	61	FG 307 C	881	39	FG 314S	837	35	FG 327	837KR	37	FG 388 C	878	57	FG 40D6	850	51
FG 269	860	41	FG 307 CB	881	39	FG 314S C	837	35	FG 327 C	837KR	37	FG 388 CB	878	57	FG 40D7	855	49
FG 269 C	860	41	FG 307 GB	881	39	FG 314S CB	837	35	FG 3274	390	62	FG 388 GB	878	57	FG 40D8	855	49
FG 274	390	62	FG 307A	882	39	FG 314S GB	837	35	FG 3274N	390	62	FG 397	836KR	36	FG 40D9	955	54
FG 274 C	390	62	FG 307A C	882	39	FG 315	881	39	FG 3305	880	38	FG 398	836KR	36	FG 410	879	57
FG 274 GB	390	62	FG 307L	882	39	FG 315 C	881	39	FG 3305L	882	39	FG 399	836KR	36	FG 410 C	879	57
FG 274N	390	62	FG 307L C	882	39	FG 315 CB	881	39	FG 3308	878	57	FG 399 C	836KR	36	FG 410 CB	879	57
FG 274N C	390	62	FG 307L CB	882	39	FG 315 GB	881	39	FG 3310	879	57	FG 400	801	28	FG 410 GB	879	57
FG 274N GB	390	62	FG 307L GB	882	39	FG 315A	837	35	FG 3311	862	42	FG 400 C	801	28	FG 4101	898	59
FG 285L	861	41	FG 307N	882	39	FG 315A C	837	35	FG 3313	845	44	FG 400 CB	801	28	FG 4102L	898	59
FG 285L C	861	41	FG 307N C	882	39	FG 315L	881	39	FG 3315L	881	39	FG 400 GB	801	28	FG 4103	898	59
FG 285L CB	861	41	FG 307N CB	882	39	FG 315L C	881	39	FG 3315S	881	39	FG 400A	801	28	FG 410L	879L	57
FG 297	813	31	FG 307N GB	882	39	FG 315L CB	881	39	FG 3323	830L	33	FG 400A C	801	28	FG 410L C	879L	57
FG 298	813	31	FG 308	878	57	FG 315L GB	881	39	FG 334	880	38	FG 400B	801	28	FG 410L CB	879L	57
FG 298 C	813	31	FG 308 C	878	57	FG 315S	881	39	FG 334 C	880	38	FG 400B C	801	28	FG 410L GB	879L	57
FG 299	813	31	FG 308 CB	878	57	FG 315S C	881	39	FG 335	392	66	FG 400N	801	28	FG 411	838	38
FG 299 C	813	31	FG 308 GB	878	57	FG 315S CB	881	39	FG 336	880	38	FG 400N C	801	28	FG 4113	846	44
FG 300	802	29	FG 308S	878	57	FG 315S GB	881	39	FG 336 C	880	38	FG 400N CB	801	28	FG 4113NR	847KR	47
FG 300 C	802	29	FG 308S C	878	57	FG 316	806	30	FG 3388	878	57	FG 400N GB	801	28	FG 4113S	847	45
FG 300 GB	802	29	FG 308S GB	878	57	FG 316 C	806	30	FG 340	822	32	FG 400S	801	28	FG 4114	836	35
FG 300A	802	29	FG 309	881	39	FG 316 GB	806	30	FG 3400	801	28	FG 400S C	801	28	FG 4117	847	45
FG 300S	802	29	FG 309 CB	881	39	FG 316L	837L	35	FG 3400N	801	28	FG 400S CB	801	28	FG 4117A	852	52
FG 300S C	802	29	FG 309 GB	881	39	FG 316L C	837L	35	FG 3400S	801	28	FG 400S GB	801	28	FG 4117N	847	45
FG 300S GB	802	29	FG 309 GB	881	39	FG 316N	806	30	FG 3401	801	28	FG 401	801	28	FG 4117S	852	52
FG 301	802	29	FG 30D14	858	52	FG 316N C	806	30	FG 3404	838	38	FG 401 C	801	28	FG 411A	838	38

FG

Intensiv Code	Shape	Page	Intensiv Code	Shape	Page	Intensiv Code	Shape	Page	Intensiv Code	Shape	Page	Intensiv Code	Shape	Page	Intensiv Code	Shape	Page
FG 411A C	838	38	FG 4235S	856	50	FG 4407R	845KR	46	FG 5009	955	54	FG 5422R	847KR	47	FG 8414B	836KR	36
FG 411R	845KR	46	FG 4236	850	51	FG 4408	878	57	FG 5102L	898	59	FG 5423R	848KR	47	FG 8417R	846KR	46
FG 411R C	845KR	46	FG 4237	850	51	FG 4409R	845KR	46	FG 5113A	852	52	FG 5505	863	43	FG 8422R	847KR	47
FG 411R GB	845KR	46	FG 4238	850	51	FG 4410	879	57	FG 5116N	847	45	FG 5505L	863	43	FG 8423R	848KR	47
FG 412	838	38	FG 4238L	856L	50	FG 4410L	879L	57	FG 5117	847	45	FG 5510	836KR	36	FG 8425	846KR	46
FG 412 C	838	38	FG 423R	848KR	47	FG 4413R	845KR	46	FG 5117S	852	52	FG 5514	836KR	36	FG 8427	847KR	47
FG 412 GB	838	38	FG 423R C	848KR	47	FG 4414	836KR	36	FG 513	846KR	46	FG 5526	847KR	47	FG 8505L	863	43
FG 4123	886Z	55	FG 423R CB	848KR	47	FG 4414B	836KR	36	FG 513 C	846KR	46	FG 5712B	837KR	37	FG 8510	836KR	36
FG 4124L	886	40	FG 423R GB	848KR	47	FG 4417R	846KR	46	FG 517	847KR	47	FG 609	837KR	37	FG 8513	846KR	46
FG 412A	838	38	FG 4240	850L	51	FG 4422R	847KR	47	FG 517 C	847KR	47	FG 609 C	837KR	37	FG 8514	836KR	36
FG 413	845	44	FG 4241	811L	63	FG 4426	889	67	FG 5181	878K	59	FG 610N	909	64	FG 8517	847KR	47
FG 413 C	845	44	FG 4243	899	63	FG 4427	847KR	47	FG 5182	878K	59	FG 610N C	909	64	FG 8525	846KR	46
FG 413 CB	845	44	FG 4245	899	63	FG 4505	863	43	FG 5195	879K	59	FG 611 C	837KR	37	FG 8526	847KR	47
FG 413 GB	845	44	FG 4249	850L	51	FG 4505L	863	43	FG 520	847	45	FG 612	835	34	FG 8614	837KR	37
FG 4132	833	66	FG 4250	379	61	FG 451	848	45	FG 5201	801	28	FG 65	848	45	FG 8710	836KR	36
FG 4135	833	66	FG 4250B	379	61	FG 4517	847KR	47	FG 5201S	801	28	FG 65 C	848	45	FG 8712	837KR	37
FG 413R	845KR	46	FG 4253	368	60	FG 4520	847	45	FG 5205	860	41	FG 707 C	835	34	FG 8714	836KR	36
FG 413R C	845KR	46	FG 4254	368	60	FG 4520	847	45	FG 5205L	861	41	FG 712 C	837KR	37	FG 9040	879	57
FG 413R GB	845KR	46	FG 4255	368	60	FG 4526	847KR	47	FG 5206	845	44	FG 8030	859	53	FG 90D1	956	54
FG 414	836KR	36	FG 4255A	368	60	FG 4610	909	64	FG 5214	835	34	FG 8040	879	57	FG 90D14	858	52
FG 414 C	836KR	36	FG 4256	379	61	FG 4612	835	34	FG 5218	830	32	FG 8040S	879	57	FG 90D2	858	52
FG 416	805	30	FG 4257	379	61	FG 4614	837KR	37	FG 5219	830	32	FG 80D3	859	53	FG 90D3	859	53
FG 416 C	805	30	FG 4258	379	61	FG 4614B	837KR	37	FG 5223	830L	33	FG 80D4	859	53	FG 90D4	859	53
FG 416 CB	805	30	FG 4258A	379	61	FG 466	877	56	FG 5225	830RL	33	FG 80D6	850	51	FG 90D6	850	51
FG 416 GB	805	30	FG 4259	379	61	FG 466 C	877	56	FG 5234	850	51	FG 80D7	855	49	FG 90D9	955	54
FG 4161	877K	58	FG 425 CB	846KR	46	FG 466 CB	877	56	FG 5235	856	50	FG 80D9	955	54	FG 9195	879K	59
FG 4161N	877K	58	FG 426	889	67	FG 467	877	56	FG 5236	850	51	FG 8113NR	847KR	47	FG 92	825	65
FG 4162	877K	58	FG 4274	390	62	FG 467 C	877	56	FG 5237	850	51	FG 8113R	846KR	46	FG 9205	860	41
FG 4163	877K	58	FG 4274N	390	62	FG 468	878	57	FG 5238	850	51	FG 8113S	847	45	FG 9205L	861	41
FG 417R	846KR	46	FG 428	889	67	FG 469	878	57	FG 5243	899	63	FG 8117	847	45	FG 9206	845	44
FG 417R C	846KR	46	FG 428 C	889	67	FG 4699	801L	29	FG 5245	899	63	FG 8195	879K	59	FG 9214	835	34
FG 4181	878K	59	FG 4300	802	29	FG 470	878	57	FG 5250	379	62	FG 8200	801	28	FG 9223	830L	33
FG 4181N	878K	59	FG 4300S	802	29	FG 470 C	878	57	FG 5253	368	60	FG 8200S	801	28	FG 9235	856	50
FG 4182	878K	59	FG 4304	835	34	FG 471	879	57	FG 5254	368	60	FG 8201	801	28	FG 9236	850	51
FG 4184	878K	59	FG 4305	880	38	FG 471 C	879	57	FG 5255	368	60	FG 8201NL	801L	29	FG 9238	850	51
FG 4185	878K	59	FG 4305L	882	39	FG 472	879	57	FG 5255A	368	60	FG 8204	835	34	FG 9243	899	63
FG 4192	879K	59	FG 4305LP	837KR	37	FG 472 C	879	57	FG 5256	379	61	FG 8206	845	44	FG 9245	899	63
FG 4193	879K	59	FG 4305S	880	38	FG 473L	879L	57	FG 5257	379	61	FG 8211	835	34	FG 9250	379	62
FG 4194	879K	59	FG 4306	877	56	FG 473L C	879L	57	FG 5257S	379	61	FG 8212S	835	34	FG 9255	368	60
FG 4195	879K	59	FG 4307	881	39	FG 474L	879L	57	FG 5258	379	61	FG 8214	835	34	FG 9259	379	61
FG 4198	811	63	FG 4307L	882	39	FG 474L C	879L	57	FG 5259	379	61	FG 8218	830	32	FG 9274	390	62
FG 4199	801	28	FG 4307N	882	39	FG 480	839	66	FG 526	847KR	47	FG 8223	830L	33	FG 9274N	390	62
FG 420	836KR	36	FG 4308	878	57	FG 480 C	839	66	FG 526 C	847KR	47	FG 8224	830L	33	FG 9305L	882	39
FG 420 C	836KR	36	FG 4308S	878	57	FG 481	849	49	FG 526 GB	847KR	47	FG 8225	830L	33	FG 9308	878	57
FG 4200	801	28	FG 4310	879	57	FG 482	849	49	FG 5274	390	62	FG 8234	850	51	FG 9315L	881	39
FG 4200S	801	28	FG 4310B	879	57	FG 482 C	849	49	FG 5274N	390	62	FG 8235	856	50	FG 9323	830L	33
FG 4201	801	28	FG 4310S	874	67	FG 483	849	49	FG 5305	880	38	FG 8236	850	51	FG 9325L	837KR	37
FG 4201NL	801L	29	FG 4311	862	42	FG 483 C	849	49	FG 5305L	882	39	FG 8237	850	51	FG 9327	837KR	37
FG 4201S	801	28	FG 4311S	862	42	FG 484	849	49	FG 5308	878	57	FG 8238	850	51	FG 9400	801	28
FG 4204	835	34	FG 4312N	863	43	FG 484 C	849	49	FG 5310	879	57	FG 8250	379	62	FG 9401	801	28
FG 4205	860	41	FG 4313	845	44	FG 485	849	49	FG 5310B	879	57	FG 8255	368	60	FG 9405L	863	43
FG 4205L	861	41	FG 4314	837	35	FG 485 C	849	49	FG 5310S	874	67	FG 8255A	368	60	FG 95	888	43
FG 4206	845	44	FG 4314L	837L	35	FG 486	849	49	FG 5311	862	42	FG 8257	379	61	FG 95 C	888	43
FG 421	836KR	36	FG 4314S	837	35	FG 5011A	909	64	FG 5312N	863	43	FG 8258	379	61	FG 95 GB	888	43
FG 4210	835	34	FG 4315	881	39	FG 505	863	43	FG 5314	837	35	FG 8259	379	61	FG 9505L	863	43
FG 4211S	835	34	FG 4315L	881	39	FG 505 C	863	43	FG 5314S	837	35	FG 8305L	882	39	FG 98	836	35
FG 4212	835	34	FG 4315S	881	39	FG 505 GB	863	43	FG 5315	881	39	FG 8305LP	837KR	37	FG 99	836	35
FG 4212S	835	34	FG 4322	881	39	FG 505L	863	43	FG 5315L	881	39	FG 8308	878	57	FG D1	956	54
FG 4213	846	44	FG 4323	830L	33	FG 505L GB	863	43	FG 5315S	881	39	FG 8310	879	57	FG D1 C	956	54
FG 4214	835	34	FG 4325	881	39	FG 5062	877K	58	FG 5325L	837KR	37	FG 8315L	881	39	FG D1 GB	956	54
FG 4218	830	32	FG 4325L	837KR	37	FG 50D14	858	52	FG 5335	392	62	FG 8315S	881	39	FG D11	858	52
FG 4219	830	32	FG 4335	392	62	FG 50D16	855	49	FG 5400	801	28	FG 8325L	837KR	37	FG D11 C	858	52
FG 4223R	830L	33	FG 4365	862	42	FG 50D18	856	50	FG 5400S	801	28	FG 8388	878	57	FG D11 GB	858	52
FG 4224	830RL	33	FG 4370	369	61	FG 50D2	858	52	FG 5401	801	28	FG 8400	801	28	FG D11A	858	52
FG 4225	830RL	33	FG 4388	878	57	FG 50D3	859	53	FG 5401	801	28	FG 8400N	801	28	FG D11A C	858	52
FG 4228	845	44	FG 4400	801	28	FG 50D34	859	53	FG 5406	877	56	FG 8400S	801	28	FG D12	848	45
FG 422R	847KR	47	FG 4400N	801	28	FG 50D4	859	53	FG 5407R	845KR	46	FG 8404	838	38	FG D13	848	45
FG 422R C	847KR	47	FG 4400S	801	28	FG 50D5	848	45	FG 5408	878	57	FG 8406A	877	56	FG D13 C	848	45
FG 422R CB	847KR	47	FG 4401	801	28	FG 50D6	850	51	FG 5410	879	57	FG 8410	879	57	FG D13L	848L	45
FG 4233	850	51	FG 4405L	863	43	FG 50D7	855	49	FG 5410L	879L	57	FG 8410L	879L	57	FG D13L C	848L	45
FG 4235	856	50	FG 4406	877	56	FG 50D8	855	49	FG 5414	836KR	36	FG 8411R	845KR	46	FG D14	858	52
FG 4235A	856	50	FG 4406B	877	56				FG 5417R	846KR	46	FG 8414	836KR	36	FG D14 C	858	52

FGL

RA

Intensiv Code	Shape	Page	Intensiv Code	Shape	Page	Intensiv Code	Shape	Page	Intensiv Code	Shape	Page	Intensiv Code	Shape	Page	Intensiv Code	Shape	Page
FG D14 GB	858	52	FG D5 C	848	45	FGL 200	801	28	RA 113	846	44	RA 274	390	60	RA 50D18	856	50
FG D15	848	45	FG D5 CB	848	45	FGL 200 C	801	28	RA 113 C	846	44	RA 274 GB	390	62	RA 50D2	858	52
FG D15 C	848	45	FG D5 GB	848	45	FGL 201	801	28	RA 113 GB	846	44	RA 300	802	29	RA 50D3	859	53
FG D15L	848L	45	FG D5L	848L	45	FGL 201 C	801	28	RA 113A	852	52	RA 301	802	29	RA 50D6	850	51
FG D15L C	848L	45	FG D5L C	848L	45	FGL 201N	801	28	RA 113A GB	852	52	RA 301S	802	29	RA 50D9	955	54
FG D16	855	49	FG D6	850	51	FGL 201N C	801	28	RA 114	836	35	RA 305L	882	39	RA 5117	847	45
FG D16 C	855	49	FG D6 C	850	51	FGL 201S	801	28	RA 114 GB	836	35	RA 305L GB	882	39	RA 5117S	852	52
FG D16 CB	855	49	FG D6 CB	850	51	FGL 201S C	801	28	RA 117	847	45	RA 308	878	57	RA 5201	801	28
FG D16 GB	855	49	FG D6 GB	850	51	FGL 206	845	44	RA 117 C	847	45	RA 308 GB	878	57	RA 5205	860	41
FG D17	855	49	FG D7	855	49	FGL 206 C	845	44	RA 117 GB	847	45	RA 30D8	855	49	RA 5205L	861	41
FG D17 C	855	49	FG D7 C	855	49	FGL 255	368	60	RA 117S	852	52	RA 310	879	57	RA 5223	830L	33
FG D17 CB	855	49	FG D7 CB	855	49	FGL 255 C	368	60	RA 117S GB	852	52	RA 310 C	879	57	RA 5236	850	51
FG D18	856	50	FG D7 GB	855	49	FGL 258	379	61	RA 11A	909	64	RA 310 GB	879	57	RA 5250	379	61
FG D18 C	856	50	FG D8	855	49	FGL 258 C	379	61	RA 11A GB	909	64	RA 311	862	42	RA 5255	368	60
FG D18 CB	856	50	FG D8 C	855	49	FGL 400	801	28	RA 130	815	64	RA 311 GB	862	42	RA 5255A	368	60
FG D18 GB	856	50	FG D8 CB	855	49	FGL 400N	801	28	RA 18L	857	48	RA 3113R	846KR	46	RA 5274	390	62
FG D19	848	45	FG D8 GB	855	49	FGL 400N C	801	28	RA 19	851	48	RA 3117	847	45	RA 5400	801	28
FG D19 C	848	45	FG D9	955	54	FGL 400S	801	28	RA 199	801	28	RA 314	837	35	RA 5400S	801	28
FG D19L	848L	45	FG D9 C	955	54	FGL 400S C	801	28	RA 19L	857	48	RA 314 C	837	35	RA 8223	830L	33
FG D19L C	848L	45	FG D9 GB	955	54	FGL 4258	379	61	RA 200	801	28	RA 314 GB	837	35	RA 8250	379	61
FG D2	858	52	FG S12 Pilot	834	64	FGL 5255	368	60	RA 200 C	801	28	RA 314S	837	35	RA 90D14	858	52
FG D2 C	858	52	FG S4 Pilot	834	64	FGL 5258	379	61	RA 200 GB	801	28	RA 314S GB	837	35	RA 9205	860	41
FG D2 GB	858	52	FG S8 Pilot	834	64				RA 200S	801	28	RA 315S	881	39	RA 9274	390	62
FG D20	888	43							RA 200S GB	801	28	RA 315S C	881	39	RA 95	888	43
FG D20 C	888	43							RA 201	801	28	RA 315S GB	881	39	RA 95 C	888	43
FG D20 CB	888	43							RA 201 C	801	28	RA 3201	801	28	RA 95 GB	888	43
FG D20 GB	888	43							RA 201 GB	801	28	RA 3205	860	41	RA A6	368	60
FG D21	888	43							RA 201S	801	28	RA 3219	830	32	RA D1	956	54
FG D21 C	888	43							RA 201S C	801	28	RA 3236	850	51	RA D1 GB	956	54
FG D21 CB	888	43							RA 201S GB	801	28	RA 3250	379	61	RA D11	858	52
FG D21 GB	888	43							RA 202	805	30	RA 3274	390	62	RA D14	858	52
FG D22	848	45							RA 202 C	805	30	RA 400	801	28	RA D16	855	49
FG D22 C	848	45							RA 202 CB	805	30	RA 400 C	801	28	RA D16 C	855	49
FG D22 CB	848	45							RA 202 GB	805	30	RA 400 GB	801	28	RA D16 GB	855	49
FG D22 GB	848	45							RA 204	835	34	RA 400S	801	28	RA D18	856	50
FG D22L	848L	45							RA 204 C	835	34	RA 400S C	801	28	RA D18 C	856	50
FG D22L C	848L	45							RA 204 GB	835	34	RA 400S GB	801	28	RA D18 GB	856	50
FG D23	856	50							RA 205	860	41	RA 401	801	28	RA D2	858	52
FG D24	856	50							RA 205 GB	860	41	RA 401 C	801	28	RA D2 C	858	52
FG D25	856	50							RA 205L	861	41	RA 401 GB	801	28	RA D2 GB	858	52
FG D25 C	856	50							RA 205L GB	861	41	RA 4035	833	66	RA D20	888	43
FG D25 CB	856	50							RA 206	845	44	RA 4036	837	35	RA D21	888	43
FG D26	856	50							RA 206 GB	845	44	RA 4037	879	57	RA D21 GB	888	43
FG D26 C	856	50							RA 208	845	44	RA 4038	882	39	RA D22	848	45
FG D3	859	53							RA 210	835	34	RA 4039	368	60	RA D22 C	848	45
FG D3 C	859	53							RA 210 GB	835	34	RA 404	838	38	RA D22 CB	848	45
FG D3 GB	859	53							RA 212	835	34	RA 405L	863	43	RA D22 GB	848	45
FG D33	859L	53							RA 212S	835	34	RA 405L GB	863	43	RA D3	859	53
FG D33 C	859L	53							RA 214	835	34	RA 4062	877K	58	RA D3 C	859	53
FG D34	859	53							RA 214 C	835	34	RA 40D18	856	50	RA D3 GB	859	53
FG D34 C	859	53							RA 216	805	30	RA 40D2	858	52	RA D4	859	53
FG D34 GB	859	53							RA 216 GB	805	30	RA 40D3	859	53	RA D4 C	859	53
FG D34A	859	53							RA 216N	805	30	RA 40D4	859	53	RA D4 GB	859	53
FG D34A C	859	53							RA 219	830R	32	RA 40D6	850	51	RA D5	848	45
FG D34A GB	859	53							RA 219 C	830R	32	RA 40D9	955	54	RA D5 GB	848	45
FG D35	859L	53							RA 220	830R	32	RA 4117	847	45	RA D6	850	51
FG D35 C	859L	53							RA 220 C	830R	32	RA 4117S	852	52	RA D6 C	850	51
FG D36	859L	53							RA 220 GB	830R	32	RA 4201	801	28	RA D6 CB	850	51
FG D36 C	859L	53							RA 223	830RL	33	RA 4205	860	41	RA D6 GB	850	51
FG D37	859L	53							RA 223 GB	830RL	33	RA 4205L	861	41	RA D7	855	49
FG D37 C	859L	53							RA 236	850	51	RA 4223R	830L	33	RA D7 C	855	49
FG D38	859	53							RA 236 C	850	51	RA 4236	850	51	RA D7 GB	855	49
FG D38 C	859	53							RA 236 GB	850	51	RA 4250	379	61	RA D8	855	49
FG D39	859	53							RA 250	379	61	RA 4255	368	60	RA D8 GB	855	49
FG D39 C	859	53							RA 254	368	60	RA 4258	379	61	RA D9	955	49
FG D4	859	53							RA 254 C	368	60	RA 4274	390	62			
FG D4 C	859	53							RA 254 GB	368	60	RA 4308	878	57			
FG D4 GB	859	53							RA 255	368	60	RA 4311	862	42			
FG D40	860	41							RA 255 C	368	60	RA 4400	801	28			
FG D4A	859	53							RA 255 GB	368	60	RA 4401	801	28			
FG D4A C	859	53							RA 255A	368	60	RA 4406	877	56			
FG D5	848	45							RA 255A GB	368	60	RA 5062	877K	58			

