

2023

Product Guide





**“Highest quality
at lowest price”**

Welcome

to the 2023 B.A. International product guide

This guide showcases all our latest handpieces and small equipment for your surgery needs. We bring together quality and affordability in one package.

Handpieces & Accessories	04
Small Equipment & Accessories	24
Handpiece Maintenance Guide	67

Handpieces & Accessories

Turbines	06
Couplings	14
Electric Micromotor	15
Contra-Angles & Straights	16



BA Ultimate Power+

BA755 & BA758

2 years guarantee



BA755 & BA758

BA Ultimate Power+ range with improved ergonomics and superb handling. Turbines have up to 22W power and come with a free instrument cassette.

KEY FACTS

- Titanium body • Fibre-optic • Quadruple spray • Quick stop function • Ceramic bearings
- Dynamic power control • Anti-retraction valve • Smaller head • Available in standard & mini head
- 2 year guarantee • Superb handling, 22W power

1. BA755 with light - standard head

Model	Code	Fitting	Light
BA755LB	BA602525	Bien Air®	✓
BA755LK	BA602505	KaVo®	✓
BA755LN	BA602535	NSK®	✓
BA755LW	BA602515	W&H®	✓
BA755LS	BA602595	Sirona®	✓

2. BA758 with light - mini head

Model	Code	Fitting	Light
BA758LB	BA602526	Bien Air®	✓
BA758LK	BA602506	KaVo®	✓
BA758LN	BA602536	NSK®	✓
BA758LW	BA602516	W&H®	✓
BA758LS	BA602596	Sirona®	✓

3. Autoclavable cassette

Model	Description
BAME010	BA Instrument Cassette, holds up to 10 instruments



1. BA755 Standard head 13mm x 11.9mm



2. BA758 Mini head 12.7mm x 10.2mm

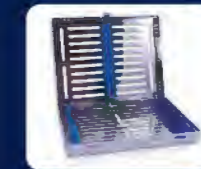

3. Instrument cassette



Quadruple spray and quick stop function



Dynamic power control 22W+



Ceramic bearings



Titanium



Range of quick connections

Fittings



Made in Germany

BA Ultimate

BA695 & BA688

2 years guarantee



BA695 & BA688

BA Ultimate range with smart coat technology for better handling. Up to 22W power.

KEY FACTS

- Up to 22W power • Fibre-optic • Quadruple spray • Anti-retraction valve • Quick stop function
- Ceramic bearings • Smaller head • New "smart coat" – scratch resistant and better grip
- Available in standard & mini head • 2 year warranty

1. BA695 with light - standard head

Model	Code	Fitting	Light
BA695LB	BA601525	Bien Air*	✓
BA695LK	BA601505	KaVo*	✓
BA695LN	BA601535	NSK*	✓
BA695LW	BA601515	W&H*	✓
BA695LS	BA601595	Sirona*	✓

2. BA688 with light - mini head

Model	Code	Fitting	Light
BA688LB	BA601526	Bien Air*	✓
BA688LK	BA601506	KaVo*	✓
BA688LN	BA601536	NSK*	✓
BA688LW	BA601516	W&H*	✓
BA688LS	BA601596	Sirona*	✓



1. BA695 Standard head 13mm x 11.9mm



2. BA688 Mini head 12.7mm x 10.2mm



Fibre-optics & Quadruple spray



Dynamic power control 22W+



Ceramic bearings

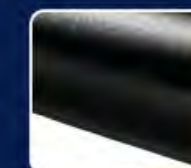

Smart Coat



Range of quick connections

Fittings



Made in Germany

BA Ultimate

BA695FM/FB

Fixed Base Turbines

1 year guarantee

**BA695**

Improved Ultimate fixed base turbine with up to 30W power and smart coat technology for better handling.

KEY FACTS

- Amazing 30W power • Quadruple spray • Anti-retraction valve
- "Smart Coat" for better grip • Midwest and Borden fittings

BA695 Ultimate Fixed Base

Model	Code	Fitting	Light
BA695FM	BA601060	Midwest 4 hole	✗
BA695FB	BA601080	Borden 2-3 hole	✗

Fittings

Midwest	
Borden	

Made in Germany

BA Optima

BA520

Fixed Base Turbines

1 year guarantee

**BA520**

Fixed base turbine with up to 20W power.

KEY FACTS

- "Slim-line" stainless steel body
- Push button bur release
- Single spray • Up to 20W power
- Available in Borden and Midwest fittings

Model	Code	Description
BA520FB	BA600088	Borden, fixed base
BA520FM	BA600068	Midwest, fixed base

Fittings

Midwest	
Borden	

Made in Japan

BA Optima

BA535FM/FB

Fixed Base Turbines

1 year guarantee

**BA535**

BA Optima fixed base turbine. Stainless steel with superior grip and up to 21W power.

KEY FACTS

- Ceramic bearings • Triple spray • Stainless steel
- Midwest and Borden fittings

BA695 Ultimate Fixed Base

Model	Code	Fitting	Light
BA535FM	BA600065	Midwest 4 hole	✗
BA535FB	BA600085	Borden 2-3 hole	✗

Fittings

Midwest	
Borden	

BA Optima

BA535QD

QD® Fitting Turbines

1 year guarantee

**BA535QD**

NEW BA Optima turbine with a lightweight design and up to 19W power.

KEY FACTS

- Ceramic bearings • Triple spray • Quick release chucking system • Available in QD fitting • Stainless steel
- Standard (BA535) and Mini (BA538) heads available

BA Optima Fixed Base

Model	Code	Fitting	Light
BA535QD	BA600070	QD	✗
BA538QD	BA600072	QD	✗

Fittings

QD	
----	--

BA Optima

BA525 & BA528

1 year guarantee



BA525 & BA528

BA Optima range - powerful entry-level turbines with a stainless steel body and up to 23W power.

KEY FACTS

- Powerful high speed turbine, up to 23W
- Ceramic bearings
- Quadruple spray
- Thermodisinfectable and autoclavable
- Available in standard & mini head
- Easy grip coating

1. BA525 with light - standard head

Model	Code	Fitting	Light
BA525LB	BA600525	Bien Air®	✓
BA525LK	BA600505	KaVo®	✓
BA525LN	BA600535	NSK®	✓
BA525LW	BA600515	W&H®	✓

2. BA528 with light - mini head

Model	Code	Fitting	Light
BA528LB	BA600526	Bien Air®	✓
BA528LK	BA600506	KaVo®	✓
BA528LN	BA600536	NSK®	✓
BA528LW	BA600516	W&H®	✓

3. BA525 without light - standard head

Model	Code	Fitting	Light
BA525B	BA600021	Bien Air®	✗
BA525K	BA600001	KaVo®	✗
BA525N	BA600031	NSK®	✗
BA525W	BA600011	W&H®	✗



1. BA525 Standard head
13.6mm x 12.3mm



2. BA528 Mini head
12.4mm x 10.4mm



Quadruple spray



Ceramic bearings



Easy Grip Coating



Range of quick connections

Fittings



BA Optima - Non Optic

BA365M/B



BA360M/B



BA Optima/Ultimate - Optic

BA360LED



BA560



BA565



BA Ultimate

Micromotor EM420

1 year guarantee



BA365

Model	Code	Description	Light
BA365M	BA630030	NSK® type coupling without light, 4 hole Midwest fitting	✗
BA365B	BA630031	NSK® type coupling without light, 2-3 hole Borden fitting	✗

BA360

Model	Code	Description	Light
BA360M	BA630000	KaVo® type coupling without light, 4 hole Midwest fitting	✗
BA360B	BA630001	KaVo® type coupling without light, 2-3 hole Borden fitting	✗

BA360LED

Model	Code	Description	Light
BA360LED	BA630500	KaVo® type LED coupling	✓

BA560

Model	Description	Light
BA560	KaVo® MULTiflex type coupling with water regulation	✓
BA560LED	KaVo® MULTiflex type LED coupling with water regulation	✓

BA565

Code	Description	Light
BA565	NSK® type coupling with light	✓
BA565LED	NSK® type LED coupling	✓

Accessories

Code	Description
TST795	Midwest to Borden Adaptor
TST790	Borden to Midwest Adaptor
OKKAVO	O-ring kit for KaVo® type coupling
OKNSK	O-ring kit for NSK® type coupling

KEY FACTS

- Plug & play electric micromotor with massive torque, internal spray and LED
- Speed range: 1,000-40,000 rpm
- Ideal for speed increasing handpieces (red band contra-angles)
- Brushless motor technology ensures long life cycle
- Compact, ergonomic, shorter and lighter motor size
- Easy to install and operate
- 2 programmable memory functions



Handpiece not included

BA Ultimate EM420

Code	Description
BA160120	Complete micromotor kit including electronics, tubing and motor

Accessories

Code	Description
BA640572	Replacement electric micromotor only for EM420 kit
BA160511	Foot switch for micromotor EM420 kit (optional)

BA Ultimate Power+

BA40LSS, BA200LTS, BA60LSS & BA280LSS

3 year guarantee

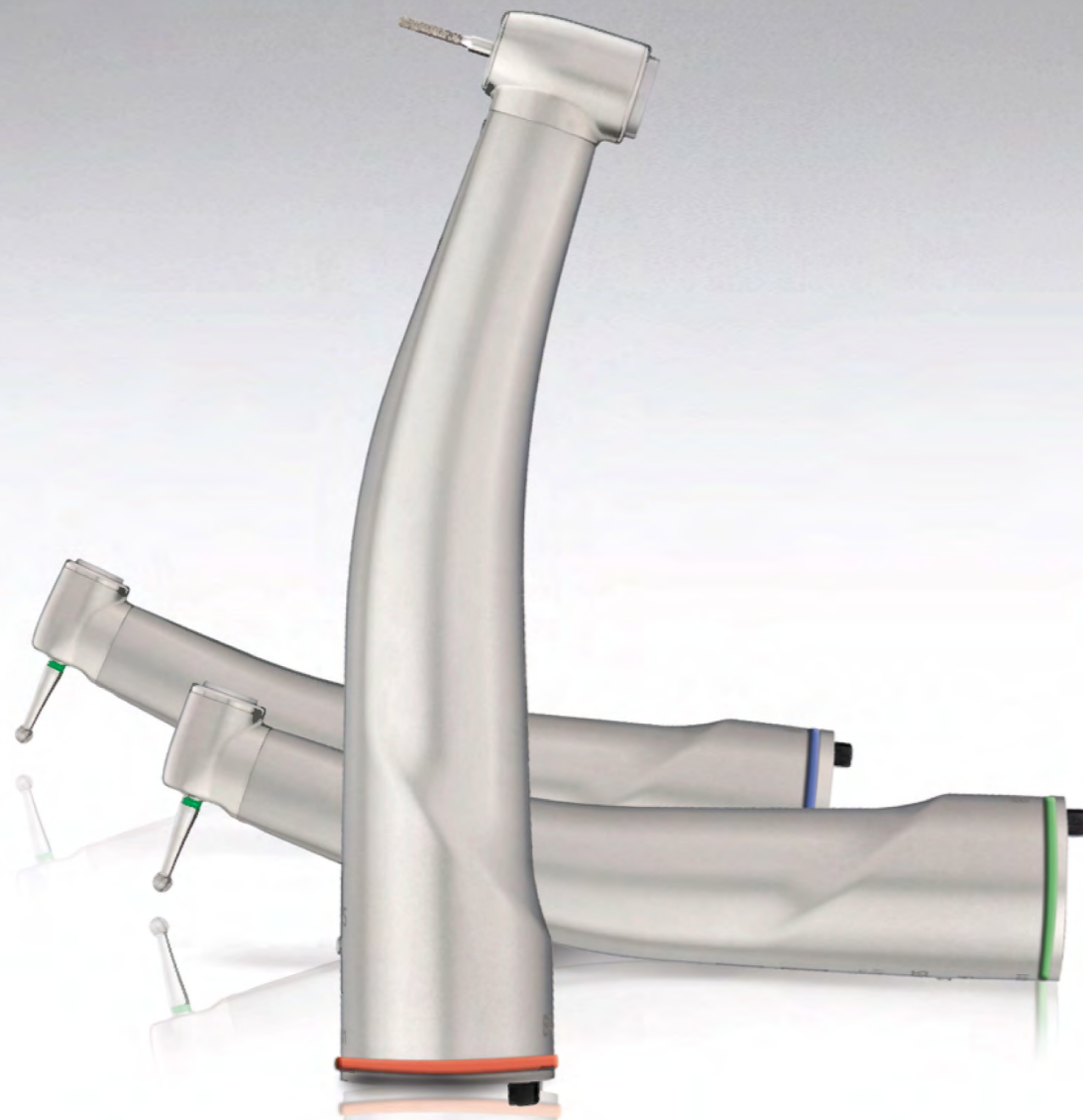

BA Ultimate Power+

BA Ultimate Power+ contra-angle and straight handpiece range with impressive 3 year warranty. Contra-angles available in 1:1, 1:5 and 6:1 ratio.

BA40LSS 1:1 Blue

KEY FACTS

- 1:1 direct ratio contra-angle • Compact and ergonomic design
- Special DLC coated bearings • Fibre-optic glass rod
- Single spray • ISO slider • Thermodisinfectable and autoclavable up to 135°C • Push button • Titanium body • Small head

Model	Code	Description	Light
BA40LSS	BA612570	Blue band 1:1	✓

BA200LTS 1:5 Red

KEY FACTS

- Speed increasing 1:5 contra-angle • Compact and ergonomic design
- Special DLC coated bearings • Fibre-optic glass rod
- Quadruple spray • ISO slider • Thermodisinfectable and autoclavable up to 135°C
- Push button • Titanium body

Model	Code	Description	Light
BA200LTS	BA612571	Red band 1:5	✓

BA60LSS 6:1 Green

KEY FACTS

- Speed decreasing 6:1 contra-angle • Compact and ergonomic design
- Special DLC coated bearings • Fibre-optic glass rod
- Single spray • ISO slider • Thermodisinfectable and autoclavable up to 135°C • Push button • Titanium body • Small head

Model	Code	Description	Light
BA60LSS	BA612572	Green band 1:1	✓

BA280LSS Straight

KEY FACTS

- Straight handpiece • Compact and ergonomic design
- Special DLC coated bearings • Fibre-optic glass rod
- ISO slider • Thermodisinfectable and autoclavable up to 135°C
- Internal water • Titanium body

Model	Code	Description	Light
BA280LSS	BA620570	Straight 1:1	✓



BA40LSS



BA200LTS



BA60LSS

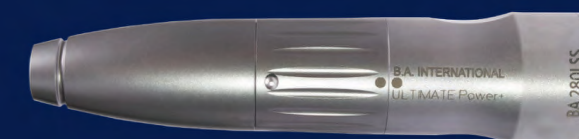

Made in Germany

BA Ultimate

BA45LS, BA250LT, BA65LS & BA280

2 year guarantee



BA Ultimate

BA Ultimate contra-angle and straight handpiece range with smart coat technology and up to 2 years' warranty. Available in 1:1, 1:5 and 6:1 ratio.

BA45LS 1:1 Blue

KEY FACTS

- 1:1 direct ratio contra-angle • Ergonomic design • Smart coat – scratch resistant and better grip • ISO slider • Single spray
- Fibre-optic glass rod • Titanium body • Made in Germany

Model	Code	Description	Light
BA45LS	BA611570	Blue band 1:1	✓
BA45S	BA611070	Blue band 1:1	✗

 Made in Germany

BA250LT 1:5 Red

KEY FACTS

- Speed increasing 1:5 contra-angle • Ergonomic design • Smart coat – scratch resistant and better grip • ISO slider • Quadruple spray
- Fibre-optic glass rod • Titanium body • Made in Germany

Model	Code	Description	Light
BA250LT	BA611571	Red band 1:5	✓
BA250T	BA611071	Red band 1:5	✗

 Made in Germany

BA65LS 6:1 Green

KEY FACTS

- Speed reducing 6:1 contra-angle • Ergonomic design • Smart coat – scratch resistant and better grip • ISO slider • Single spray
- Fibre-optic glass rod • Titanium body • Made in Germany

Model	Code	Description	Light
BA65LS	BA611572	Green band 6:1	✓
BA65S	BA611072	Green band 6:1	✗

 Made in Germany

BA280 Straight

1 year guarantee

KEY FACTS

- Straight 1:1 handpiece • Internal water • Thermodisinfectable
- Autoclavable • Fibre-optic/non fibre-optic

Model	Code	Description	Light
BA280L	BA621575	Straight 1:1	✓
BA280	BA280	Straight 1:1	✗

 Made in Japan



BA45LS



BA250LT



BA65LS



BA Optima

BA25E, BA65E, BA45E, BA66E & BA175E



BA Optima Contra-angle and Straight handpieces

Superior, ergonomic and smooth design.

(No light and no spray)

BA25E 1:1

KEY FACTS

- Latch type
- No light • No spray
- Autoclavable

BA45E 1:1

KEY FACTS

- Push button
- No light • No spray
- Thermoisinfectable
- Autoclavable

BA175E 1:1

KEY FACTS

- Straight
- No light • No spray
- Thermoisinfectable
- Autoclavable

Model	Code	Description
BA25E	BA611083	Latch type 1:1

Model	Code	Description
BA45E	BA611084	Push button direct 1:1

Model	Code	Description
BA175E	BA620080	Straight 1:1

BA65E 4:1

KEY FACTS

- Screw-in
- No light • No spray
- Thermoisinfectable
- Autoclavable

BA66E 4:1

KEY FACTS

- Push button
- No light • No spray
- Thermoisinfectable
- Autoclavable

Model	Code	Description
BA65E	BA611085	Screw in prophy 4:1

Model	Code	Description
BA66E	BA611086	Push button 4:1

Made in Japan

BA Optima & Ultimate

Air Motors



Optima BA602E/BA604E

Fittings



Ultimate BA602ES/BA604ES & BA604EL

Fittings



BA Optima & Ultimate Air Motors

KEY FACTS

- Midwest or Borden fittings
- Fits standard or short contra-angles • Autoclavable
- Thermoisinfectable (except BA604EL)
 - Forward/reverse directional control
- Speed range: 5,000-25,000rpm (3 bar)

BA602E/BA604E Optima (external spray)

Model	Code	Description	Light
BA602E	BA640085	2 hole Borden, external spray	✗
BA604E	BA640065	4 hole Midwest, external spray	✗

BA602ES/BA604ES/BA604EL Ultimate (internal spray)

Model	Code	Description	Light
BA602ES	BA641085	2 hole Borden, internal spray	✗
BA604ES	BA641065	4 hole Midwest, internal spray	✗
BA604EL	BA640565	6 hole Midwest, internal spray, with light, Autoclavable only.	✓

Made in Japan

BA Optima

BA101 & Accessories

“Bestseller”

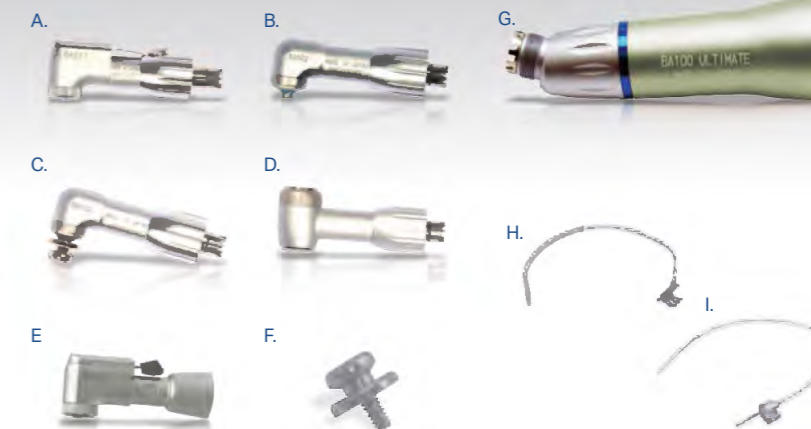

Blue band 1:1 contra-angle handpiece.

(No light and no spray)

KEY FACTS

- Blue band contra-angle • 1:1 direct ratio • Standard E-fitting connection • Autoclavable • Latch type bur release.

BA101 Contra-Angle

Code	Description
BA101	Latch type

Accessories

Code	Description	Code	Description
A. BA001	Latch type contra-angle head for BA101	F. C186020	Mandrel
B. BA002	Screw-in type contra-angle head for BA102	G. BA100	Direct ratio 1:1 shank
C. BA003	Snap-on type contra-angle head for BA103	H. C032701	Water attachment for contra-angle handpiece
D. BA005	Push button type contra-angle head for BA105	I. H019711	Water attachment for straight handpiece

Made in Japan

*Not made in Japan

Small Equipment & Accessories

Endodontics	26	Curing Lights	50
Lubrication Units	30	Heatsealers	53
Lubrication Accessories	32	X-Ray Viewers & Alginate Mixer	54
Smart Cleaner	33	Ultrasonic Bath	55
Implant & Surgical Units	34	Capsule Mixer & Micromotor	56
Hygiene (Scaling & Polishing)		Extra-Oral Suction Unit	57
- Scaling Units	40, 44, 46	Laboratory Equipment	58
- Handpieces	45, 48	LED Bulbs	65
- Scaling Tips	42, 45, 47	Multigauge & Steritube	66
- Prophylaxis Powder	43		
- Hygiene Units	49		

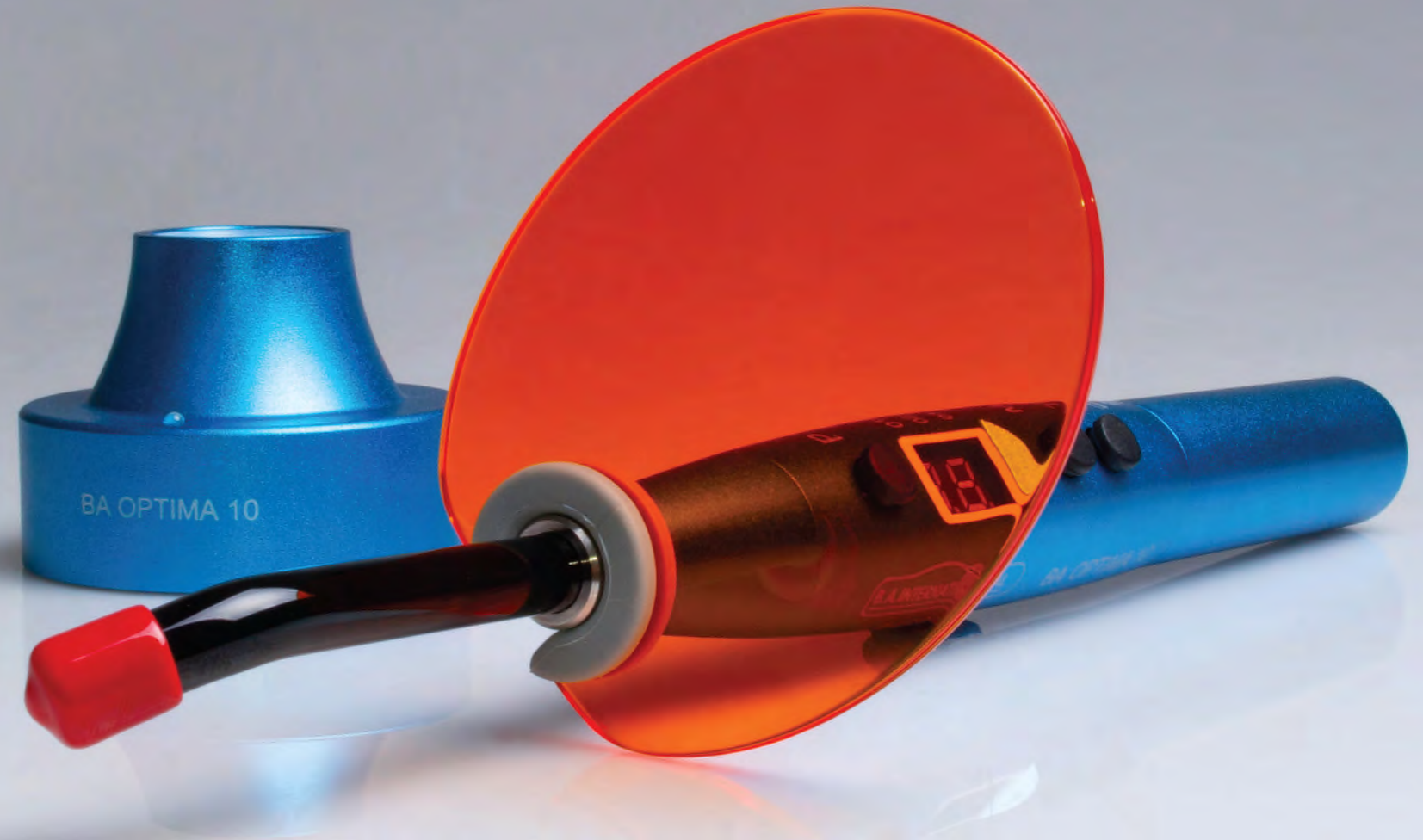

BA Optima E+

Endodontic Unit with Apex Locator



BA Optima E+ Endodontic Unit with Apex Locator

A cordless & brushless endodontic motor system with inbuilt apex locator, reciprocating features and presets for many file types including EdgeEndo.

The most notable feature of the BAE380R is its inbuilt apex locator. This tool provides integrated length determination, real-time display of file location in the canal, and automatic stop or reverse functions for when the file reaches the apical stop. The unit can also work as a standalone apex locator using the EAL setting.

KEY FACTS

- Brushless endo motor with inbuilt apex locator
- Endodontic motor with integrated apex locator
- 6:1, 360° rotatable contra-angle head
- Compatible with most common file systems, incl. EdgeEndo
- "SGP" Safety Glide Path (reciprocation) mode
- Various preset modes available
- Ability to set own parameters and save using memory programs
- Small head diameter (8mm) and height (9.7mm): more visibility during operation
- Speed: 100-2500 rpm; torque: 0.4Ncm-5.0Ncm
- Smooth rotation and quiet operation for patient comfort.

DIMENSIONS

H: 20cm (23cm with charger base) ø: ~3cm (motor), ~8cm (charger base)

BA Optima BAE380R

Model	Code	Description
BAE380R	BA182380	Endodontic Motor with inbuilt Apex Locator
-	BA182611	Contra-angle head only for BAE380R



Wireless charging



Easy to read OLED display



Integrated contra-angle

BA Optima Endodontic Unit



B.



C.



D.

BA NiTi Endo Contra-Angle

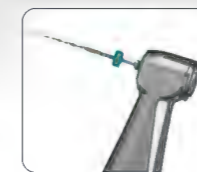
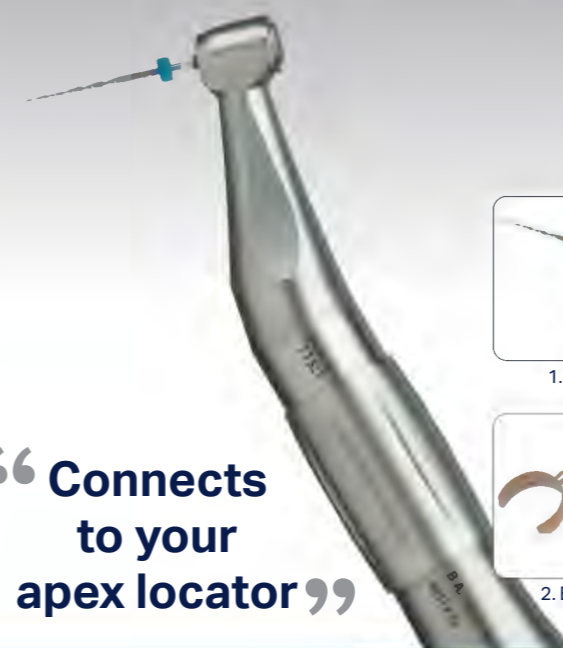

1. BAE45



2. BA Clips

BA Optima Endodontic Contra-angle & Head



1. BAE05

2. BAE15

BAE300/350

Compact and ergonomic, simple to use table top endodontic motor.

KEY FACTS

- Auto reverse function • Useable on battery for up to 5 hours or with supplied adaptor
- Reducing gear ratio up to 16:1 • Torque control from 0.6 to 5.2N.cm • 9 programs
- Foot control and handpiece stand included • Dimensions H139 x W110 x D196mm

BA Optima E+ BAE300

Model	Description
A. BAE300	Complete unit with A-type motor (BAE05)
C. BAE05	Endo head for A-type motor

BA Optima E+ BAE350

Code	Description
B. BAE350	Complete unit with E-type motor (BAE15)
D. BAE15	Endo contra-angle head for E-type motor

BAE35/45

KEY FACTS

- Endodontic contra-angle with torque control, direct connection to the motor (no tabletop unit required) • 2 models available: BAE35 115:1 reducing handpiece for electric micromotors, and BAE45 66:1 for air motors • Can be used with all the common NiTi files • Easy torque setting with the unique magnetic ring (5 torque levels) • Retro-rotation system prevents any excessive torque • Optional apex clip connection

1. BA NITI

Code	Description
A. BAE35	115:1 Endo contra-angle
B. BAE45	66:1 Endo contra-angle

2. BA Clip

Code	Description
BAE35C1	2mm Clip for BA NiTi endo c/a
BAE35C2	1.5mm Clip for BA NiTi endo c/a

BAE05/BAE15

Endodontic contra-angle and head.

KEY FACTS

- BAE05 - Endo head for A-type motor, compatible with BAE300 unit and BAE370R unit • BAE15 - Endo contra-angle for E-type motor, compatible with BAE350 unit • Gear ratio: 16:1

BA Optima BAE05/BAE15

Code	Description
1. BAE05	Endo head for A-type motor
2. BAE15	Endo contra-angle for E-type motor

BA Ultimate CL Lubrication Units



BA Ultimate CL Lubrication Units

BA Ultimate CL lubrication unit – lubricates up to 3 handpieces in less than a minute at the touch of a button and prolongs the life of your handpieces.

KEY FACTS

- Optimal handpiece lubrication for every handpiece
- Fast and simple to use
- Uses standard handpiece oil
- Cleans the internal tubing of handpieces
- Dedicated chuck cleaner and lubricator
- Adaptors to fit any handpiece type (see pg. 32)
- Extends handpiece lifetime
- Runs on mains or compressed air (recommended)
- Cleaner and safer for practice staff

DIMENSIONS

H385 x W295 x D295mm

Code	Description
BA170000	Ultimate CL0 unit; 3 turbines.
BA170001	Ultimate CL1 unit; 1 motor, 2 turbines
BA170002	Ultimate CL unit; 2 motors, 1 turbines

Accessories for Ultimate CL - see page 32



Up to 3 handpieces



Digital display



Dedicated chuck cleaner

Key Benefits of the Ultimate CL Unit

Saves you time and money.



Lubricates and cleans 3 handpieces in less than a minute and no mess to clean up.



Reduces future handpiece repair costs and increases the life span of your handpieces.



BA Ultimate CL Unit Accessories



BA Ultimate Manual Lubrication

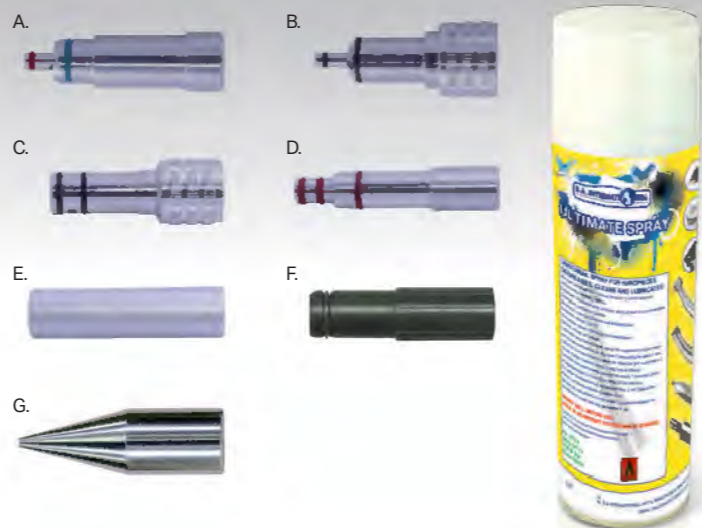

BA Smart Cleaner



Accessories and consumables for the BA Ultimate CL lubrication unit.

Adaptors for Ultimate CL Unit

Code	Description
BA690050	KaVo® adaptor
BA690051	W&H® adaptor
BA690052	Bien Air® adaptor
BA690053	NSK® adaptor
BA690055	E-fitting adaptor
BA690059	Sirona® adaptor

Accessories for Ultimate CL Unit

Code	Description
BA690070	Blisters - pack of 3
BA690071	Pads - pack of 10
BA690073	Oil tray

Accessories and consumables for manual lubrication.

Nozzles for BA Ultimate Spray Can

Code	Description
A. NOZW	Nozzle for W&H® type handpiece
B. NOZBAIR	Nozzle for Bien Air® type handpiece
C. NOZS	Nozzle for Sirona® type handpiece
D. NOZK	Nozzle for KaVo® type handpiece
E. NOZN	Nozzle for NSK® type handpiece
F. NOZE	Nozzle for E-fitting
G. NOFB	Nozzle for Fixed based type

BA Ultimate Spray

Code	Description
BA690080	Single can 500ml

KEY FACTS

Clears water blockages in handpieces.

1. Attach handpiece and unscrew Smart Cleaner.
2. Remove plunger and fill Smart Cleaner with water.
3. Replace plunger and attach the screw thread back on the Smart Cleaner.
4. Turn clockwise to force water from the Smart Cleaner through the handpiece or coupling to remove the blockage.

BA Smart Cleaner

Code	Description
A. BACleaner1	Full Kit Including BA Smart Cleaner, Smart Cupper, Smart Connect and Borden to Midwest adaptor
B. SmartCleaner5	Fits standard Midwest turbines
C. BACleaner	Smart Cleaner including Borden to Midwest adaptor
D. TST795	Borden to Midwest adaptor
E. Smartcupper1	Adaptor for multiple spray
F. Smartconnect	Adaptor for E-fitting handpiece



BA Optima Implant & Surgical Unit



OS600L

New, stylish and compact implant surgical unit with powerful motor and real-time speed and torque display during operation

KEY FACTS

- Increased accuracy during surgery with real-time display of actual torque load and RPM on the LCD display.
- Powerful LED optic motor • Up to 40,000 RPM at the motor • 6 different program functions for various surgery procedures with option for user to change values of gear ratio, torque, rotation speed, direction of rotation irrigation flow • 9 memory programs to save set values of each function • Torque limit function: automatic stop when torque load exceeds defined torque value
- Calibration function • Handpiece not included

OS600L

Model	Code	Description
OS600L	BA160510	Complete implant surgical unit

Accessories

Code	Description
BA160530	Motor only for OS600L
BA160540	Motor connection cable for OS600L
BA690110	Autoclavable irrigation line

“Real-time display of torque and speed”

Compatible handpiece:
OS20L 20:1 Speed Reducing
Premium Surgical Handpiece

Code: BA660080

KEY FACTS

- High performance 20:1 surgical handpieces • Torques up to 70N.cm • Fully dismantlable for superior hygiene control
- Thermodisinfectable and autoclavable
- Anti-scratch



Optima Surgical Handpieces



OS20

20:1 Speed Reducing PowerSurge Access Handpieces

KEY FACTS

- High performance 20:1 surgical handpieces
 - Torques up to 70N.cm
- Fully dismantlable for superior hygiene control
 - Thermoisinfectable and autoclavable
 - Anti-scratch

Model	Code	Description
OS20X	BA660080	Latch type
OS20L	BA660580	PB type

PowerSurge Premium Handpieces



PS20

20:1 Speed Reducing Premium Surgical Handpieces

KEY FACTS

- High performance 20:1 surgical handpieces
 - Torques up to 80N.cm
- Fully dismantlable for superior hygiene control
 - Thermoisinfectable and autoclavable

Model	Code	Light
PS20X	BA660070	✗
PS20L	BA660570	✓
PS20LED	BA660571	✓
Code	Description	
BA690013	Irrigation clip for PS20X/L/LED	

PowerSurge Premium Handpieces



PS11

1:1 Surgical Straight Handpieces

KEY FACTS

- High performance 1:1 surgical straight handpieces
 - Torques up to 80N.cm
- Fully dismantlable for superior hygiene control
- Thermoisinfectable and autoclavable
- No air projection to prevent necrosis & bacterial infection

Model	Code	Light
PS11X	BA660072	✗
PS11LED	BA660574	✓

BA Optima Implant & Surgical Unit



OS500

The BA Optima Surgical Unit OS500 is the simple no fuss solution to your surgical needs. With its powerful motor and wide speed range from 300-40,000rpm at the motor, it offers you complete control and accuracy over all of your surgical procedures.

With its ergonomic design, simple to use interface, multifunctional foot pedal and 20:1 speed decreasing surgical handpiece included, it is the complete package that enables clinical excellence without complication from the moment you turn it on.

KEY FACTS

- Includes a 20:1 surgical handpiece OS20P • Handpiece has optional internal and external irrigation
- Powerful 50N/cm² handpiece • Independently control speed, torque and irrigation • Easy-to-use controls
- Multifunctional foot control • 10 programmable memory functions to store your personal settings

DIMENSIONS

H135 x W195 x D220mm

“ Simple and easy to use ”

Model	Code	Description
OS500	BA160508	Complete Optima Surge unit
OS20P	BA660077	Optima Surge 20:1 handpiece

Code	Description
1091862	Irrigation line for OS500
OS500P21	Lead for OS500
OS500P22	Motor for OS500



OS20P Handpiece



Digital Display

BA Ultimate UC500L

Scaler & Air Polisher



UC500L

The new dental scaling and air polishing systems providing efficient and comfortable plaque removal.

KEY FACTS

- Reduces plaque and pigment adhesion without scratching the surface of the teeth
- Dual water supply
- A more comfortable treatment for your patients
- Lightweight, three-section air polishing handpiece for easier cleaning
- Automatic identification of scaling mode
- Range of titanium alloy tips and accessories
- Small-caliber nozzle gives more concentrated air polishing and more efficient plaque removal
- 360° rotatable, pre-bendable nozzles efficiently eliminate biofilms and thoroughly clear dead ends

DIMENSIONS

H360 x W290 x D120mm

UC500L

Model	Code	Description
UC500L	BA150100	Complete Ultimate UC500L dental scaler and prophy unit

Accessories

Code	Description
BA150150	BAC5P Air Polisher Handpiece for supragingival treatment
BA150155	BAC5B Air Polisher Handpiece for subgingival treatment
BA150160	BAC5L Ultrasonic Handpiece
BA150170	Single Use Nozzles (pack of 10) (Subgingival Air Polisher Tips)



Large screen smart touch control



Elliptical vibration



Thorough removal of plaque



Small-caliber nozzle



Multi-function foot pedal

BA Ultimate UC500L

Tips



BA Ulticlean Prophylaxis BA Ultimate UC500L

Powder Series



Cart System



Tips

Scaling, periodontic and endodontic tips range for UC500L unit.

Model	Code	Description
BAC33E	BA150180	Used to remove calculus deep in the periodontal pocket and rinse the periodontal pocket
BAC50RE	BA150181	Used for subgingival calculus detection and subgingival scaling (Right Angle)
BAC50LE	BA150182	Used for subgingival calculus detection and subgingival scaling (Left Angle)
BAC52E	BA150183	Used for supragingival scaling and removal of dental calculus / Plaque
BAC59E	BA150184	Used for subgingival calculus detection and subgingival scaling
BAC56E	BA150185	Used for removing larger calculus

Model	Code	Description
BAC60E	BA150195	Used for preparation and irrigation of root canal
BAC62E	BA150196	Used for Root canal Irrigation
BAC90E	BA150188	Used for cleaning implant and restoration
BAC94E	BA150186	Used for cleaning implant and restoration
BAC95E	BA150187	Used for cleaning implant and restoration

Prophylaxis Powder

KEY FACTS

Prophylaxis powder for professional dental cleaning (including severe discolouration) and biofilm (plaque) removal. All powders are very fine and evenly grained. This results in selective abrasion of plaque and at the same time is gentle on soft tissue and dental hard tissues.

Code	Description
A. 9796714	Ulticlean Prophylaxis Powder STANDARD (pack of 4) For supragingival use Base: Bicarbonate (Lemon)
B. 9796715	Ulticlean Prophylaxis Powder STANDARD (pack of 4) For supragingival use Base: Bicarbonate (Peppermint)
C. 9796716	Ulticlean Prophylaxis Powder PERIO PLUS (pack of 4) For sub- and supragingival use Base: Tagatose

Complete Cart System

KEY FACTS

Very well-designed cable management system allows you to have an ultra-hygienic & functional working station. With our high quality wheel system, our cart is designed to give you the best maneuverability around your working space. Effective space management with it's frontal storage slots allows you easy access to your Ulticlean powders and dispenser.

DIMENSIONS
H826.5 x W330 x D361mm

Code	Description
BA150300	Complete Cart system for Ultimate UC500L.

BA Optima

Piezo Unit

EMS® & Satelec® type piezo unit, with or without light



LED version

Non LED version

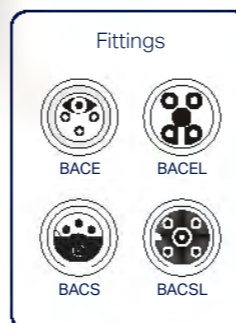

Fittings

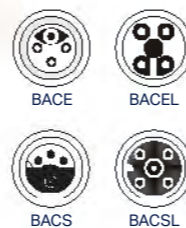

BAC200E/EL & BAC200S/SL

EMS® & Satelec® type piezo unit, with or without light

The new ultrasonic all-rounder – removes calculus without damaging enamel and provides smart maintenance treatment for implants. Patients feel good and more assured.

KEY FACTS

- EMS® & Satelec® type piezo unit with independent water supply
- 2 versions available (with/without light)
- Ergonomic design
- Intuitive power control
- Range of power options, from gentle perio power to maximum power
- Handpiece is fully autoclavable

Included with each unit

- 2 handpieces, 1 tip wrench, 3 tips and 1 tip card.

DIMENSIONS

H180 x W153 x D215mm

BAC200 - complete EMS® & Satelec® type piezo unit

Code	Description
BAC200E	Complete EMS® piezo unit without light
BAC200EL	Complete EMS® piezo unit with light
BAC200S	Complete Satelec® piezo unit without light
BAC200SL	Complete Satelec® piezo unit with light

Handpieces & Handpiece Kits for BAC200 or BAC100

- Handpiece kits include one handpiece, tip changer, tip card and 3 tips.



Handpiece kit (also available with LED handpiece)

Code	Description
BAC250E	Handpiece kit non LED (EMS® type)
BAC250EL	Handpiece kit LED (EMS® type)
BAC250S	Handpiece kit non LED (Satelec® type)
BAC250SL	Handpiece kit LED (Satelec® type)
BAC20044066	BACE - non LED handpiece only (EMS® type)
BAC20044067	BACEL - LED handpiece only (EMS® type)
BACS	Non LED handpiece only (Satelec® type)
BACSL	LED handpiece only (Satelec® type)
BAC227	BA Torque Wrench

Tips & Accessories for BAC200 or BAC100



Code	Description
BAC261E	Tip to remove supragingival calculus
BAC262E	Tip to remove supragingival, subgingival & interdental calculus
BAC263E	Perio tip for subgingival use
BAC251E	Pack of tips (BAC261E, BAC262E, BAC263E)
BAC20044077	Pack of 3x BAC261E tips
BAC20044078	Pack of 3x BAC262E tips
BAC20044079	Pack of 3x BAC263E tips
BAC20044065	Fibre-optic cable
BAC20044064	Non fibre-optic cable
BAC20044068	Replacement water bottle for BAC200E/EL only
BAC10045160	Water supply hose for BAC100E/EL only

Swiss Design

BA Optima

Ultrasonic Scaling Unit

EMS® type piezo unit, with or without light

Please see page 41 for handpieces and accessories



BAC100E/EL

Ultrasonic scaling unit designed for surgeries that already have a water supply.

KEY FACTS

- EMS® type piezo unit for direct connection to existing water supply • 2 versions available (with/without light)
- Ergonomic design • Intuitive power control • Intuitive power control • Range of power options, from gentle perio power to maximum power • Handpiece is fully autoclavable

Included with each unit

- 1 handpiece, 1 tip wrench, 1 tip, 1 tip card and 1 water supply hose.

DIMENSIONS

H96 x W153 x D215mm

BAC100 - complete EMS® type piezo unit

Code	Description
BAC100E	Complete EMS® piezo unit without light
BAC100EL	Complete EMS® piezo unit with light



BA Ultimate

Tips

Pack of 3 tips - please choose correct fitting*

Please see page 44 for treatment centre



Tips

Scaling, periodontic and endodontic tips range. Available for BA International, EMS, Satelec, NSK and Sirona type handpieces.

Scaling Tips for BA Ultimate treatment centre

Code	Description
BAC161	Scaling - Removes Supragingival Calculus
BAC162	Scaling - Removes Pragingival Heavy Calculus*
BAC163	Scaling - Removes Calculus On Supragingival, Subgingival & Interdental*
BAC164	Scaling - Removes All Supragingival Calculus
BAC165	Scaling - Removes Supragingival & Neck Calculus
BAC166	Scaling - Removes Supragingival Heavy Calculus

Perio & Endo Tips for BA Ultimate treatment centre

Code	Description
BAC171	Perio - Removes Supragingival Calculus
BAC173	Perio - Subgingival Perio use
BAC174	Perio - Removes Supragingival & Interdental Calculus
BAC151	Endo - 120 For Anterior Root Canal Cleaning
BAC152	Endo - 95 For Posterior Root Canal Cleaning
BAC153	Endo - For Lateral Condensation

*Note: Not available for Sirona Type Handpieces

Please suffix tip with 'E' for EMS and BAC100/200 E/EL type handpieces, 'S' for Satelec® and NSK® and BAC100/200 S/SL type handpieces, 'A' for Sirona® type handpieces e.g. BAC161E.

BA Ultimate Hygiene Range



BA Ultimate Air Scaler

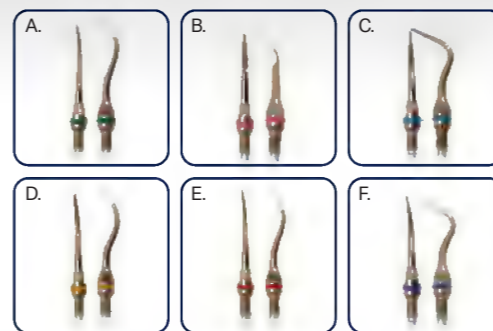

BA Ultimate Air Polisher



BAC150

BA Ultimate Hygiene Range includes a wide range of products for all your needs: autoclavable treatment centres including handpieces and a range of tips covering scaling, periodontic and endodontic applications.

KEY FACTS

BA Ultimate Autoclavable Treatment centre available for BA/EMS® type, Satelec® and Sirona® type handpieces. Each treatment centre contains a fully autoclavable handpiece, 2 scaling tip (BAC161, BAC164), 1 perio tip (BAC173), 1 endo head (BAC151), a tip changer and an endo wrench.

BA Ultimate Treatment Centre

Code	Description
BAC150E	Autoclavable treatment centre with BA/EMS® type handpiece
BAC150S	Autoclavable treatment centre with Satelec® type handpiece
BAC150A	Autoclavable treatment centre with Sirona® type handpiece
BAC150AL	Autoclavable treatment centre Sirona® type handpiece with light

BA Ultimate tip changer

Code	Description
BACS122	Tip changer for scaling & perio tips (EMS® Satelec®)
BACS127	Tip changer for scaling & perio tips (Sirona®)



BAC150E



BAC150A
BAC150AL



BAC150S

BA17K

KEY FACTS

- Connections for Midwest, Borden & KaVo MULTiflex couplings
- Operates at 17Khz for near silent operation
- Includes 3 tips (A,B,C)

BA Ultimate Air Scaler

Code	Description
BA17KK	For KaVo® MULTiflex coupling connection
BA17KM	Supersonic scaler with Screw-on connection (Midwest 4-Hole)
BA17KB	Supersonic scaler with Screw-on connection (Borden 2-Hole)

BA Ultimate Scaler Tips

Code	Description
A.5031931	Green tip for supragingival and subgingival scaling
B.5037171	Pink tip for removing obstinate tar and stain adhesion
C.5037191	Blue tip for scaling in crown interproximal and root proximal
D.5037121	Removal of stubborn supragingival and interdental calculus
E.5031932	Sickle type scaler tip for fine scaling, supragingival and interdental
F.5037131	Dark blue tip for scaling supragingival and interproximal spaces

Made in Japan

BA720

KEY FACTS

- Air prophylaxis
- Effectively removes plaque and tooth stains
- Ideal interproximal and surface cleaning for orthodontic bonding

BA720 Ultimate Air Polishers

Fitting	Black	White
KaVo®	BA670002	BA720K
W&H®	BA670012	BA720W
Bien Air®	BA670022	BA720B
NSK®	BA670032	BA720N
Sirona®	BA670092	BA720S
Midwest	BA670062	-

Accessories

Code	Description
3162031	Spare head for BA720

Made in Japan

Fittings



Ulticlean Air Polishing Powders 4 x bottles

Code	Description
9796714	Prophylaxis powder, lemon flavour, 4 x 300g
9796715	Prophylaxis powder, peppermint flavour, 4 x 300g
9796716	Prophylaxis powder, perio plus, 4 x 100g

BA Ultimate LED Curing Light

“Ultimate power, elegant design”



BASE290 LED Curing Light

KEY FACTS

- Cordless LED curing light • Stylish design - easy handling • Different curing modes available: 2 standard modes, 2 boost modes • Light power up to 3000mW/cm²
- Wide emission spectrum to polymerize all materials (380nm-500nm) • Easy-to-use 'Navikey' and LED indicators for simple operation • Various modes of operation with settings for power levels and curing durations • Power saving mode • Weight: 152g

BA Ultimate BASE290 LED Curing Light & Accessories

Code	Description
BA110200	BASE290 LED Curing Light
BA110540	Barrier sheaths (Pk 50)
BA110545	Protection shield for BASE290



LED Light



Curing Light
225mm

 British Design

BA Optima LED Curing Light



Optima 10

KEY FACTS

- Light and compact curing light with a curing output of 1200mw/cm² • 3 curing modes: full power, ramp and pulse • Wave length 420-480nm • Digital display and simple to use • Available in 8 different colours

BA Optima Curing Lights

Code	Colour	Code	Colour
BASES10	 Black	BASES50	 Silver
BASES20	 Blue	BASES60	 Pink
BASES30	 Red	BASES70	 Purple
BASES40	 Green	BASES80	 Jade Green

Accessories for BA Optima 10

Code	Description	Code	Description
BASES05	Replacement light guide	BAOPT010	Eye protector shield
BAOPT004	Battery		

BA Optima LED Curing Light



Optima V BASE200

Powerful yet simple curing light with compact, efficient design.

KEY FACTS

- Light intensity: +1000mW/cm² • Wavelength range: 420-490nm • Three different time settings available (5, 10, 15 sec) • Inbuilt battery with micro-USB charging port
- Allows curing of most composites in up to 10 seconds

BASE200 Curing Light

Model	Code	Description
BASE200	BA110180	LED Curing Light

Accessories

Code	Description
BA110606	Light guide
BA110603	Protective shield
BA110605	Curing light support

BA Ultimate LED Curing Light



BASE280

Dual-light LED curing light designed for use with a wide range of restorative materials.

KEY FACTS

- Dual-light technology: 2 blue and 2 UV spectrum LEDs
- Light intensity: +2000mW/cm² • Wavelength range: 360-490nm
- Allows curing of most composites in up to 10 seconds
- 3 modes available: full power, ramp up and pulse
- In-built radiometer, thermometer and cooling fan

BASE280 Ultimate Curing Light

Model	Code	Description
BASE280	BA110150	LED Curing Light

Accessories

Code	Description
BA110624	Light guide

BA Optima Light Meter



BASE210

KEY FACTS

- Digital radiometer • Accurately measures curing light intensity in mW/cm² • Room temperature display
- Accurately measures light tips from 8mm-10mm in diameter • Range of intensity 0-2050mw/cm²

BA Optima Light Meter

Code	Description
BA110505	BA Optima Light Meter

BA ULTlseal Heatsealer



BASE740

NEW Electronic thermosealing machine for continuous cycle processing.

KEY FACTS

- Compact design with sealing lever positioned at the front • Resistant, reliable, easy to use • Tabletop or flush-mounted • Compliant with UNI 868-5 and EN 11607-2 standards • Sealing strip: 12mm, sealing area width: 310mm • Power: 220-240V, 50/60Hz • Weight: 7.6kg
- Dimensions: W473 x H200 x D235mm

ULTlseal BASE740

Code	Description
BA140600	Complete heatsealer unit with multiplugs

BA Ultimate

X-Ray Viewer



BA Ultimate

Alginate Mixer



BA Ulticlean

Ultrasonic Bath



“The perfect mix at the touch of a button”

BASE600/650

KEY FACTS

- Table top or wall mounted
- 2 different sizes available
- 2 x 8W (BASE600) or 2 x 16W (BASE650) halogen bulbs
- BASE600 Dimensions H165 x W300mm
- BASE650 Dimensions H205 x W380mm

BA Ultimate X-Ray Viewer

Code	Description
BASE600	Ultimate X-Ray viewer, screen size 300 x 165mm
BASE650	Ultimate X-Ray viewer, screen size 380 x 205mm

BASE900

KEY FACTS

- Intensive mixing optimises the setting reaction in the alginate, speeding up setting time
- Perfectly mixed, smooth and accurate alginate impressions that look like silicone
- Digital display
- 3 default programmes: 8, 10 & 12 seconds
- Speed up to 3400rpm
- Capacity: 25 – 100g (bowl)
- Easy to use, easy to clean
- Hygienic
- Modern design
- Dimensions H290 x W205 x D250mm

BA Alginate Mixer (BASE900)

Code	Description
BA180005	Alginate Mixer
AL200	Mixing Cup
AL201	Water Dosing Bottle

BASE400

KEY FACTS

- State of the art 4 litre capacity ultrasonic bath with optional heat
- Wave technology gives a uniform cleaning pattern that eliminates hot spots and weak areas, giving constant power and consistent output
- Smooth, quiet operation and easy-to-clean housing
- Hinged automatic locking lid – prevents opening during cycle
- Easy-to-use built-in drain facility
- Touch pad controls with 60 minute timer

DIMENSIONS

H267 x W375 x D267mm

Code	Description
BASE410	BA Ulticlean Ultrasonic Bath (UK)
BASE400	BA Ulticlean Ultrasonic Bath (EU)
BASE420	BA Ulticlean Ultrasonic Bath (AUS)
BASE450	Accessory kit for BASE400/BASE410 Ulticlean

Description
Accessory kit (BASE450) for BA Ulticlean ultrasonic bath, contains:
• 1 full basket
• 1 positioning cover.
• 1 half positioning cover.
• 2 x 600ml beakers.
• 1 bur box.
• 1 bur tray.

BA Optima

U-Mix Capsule Mixer



BASE800

KEY FACTS

- Touch pad selector and digital LCD display
- Programmable mixing presets with memory
- Ergonomic design
- High revolution for better performance
- Speed: 4,800 oscillations per minute
- Noiseless and stable operation
- Easy operation and study capsule holder
- Safety micro switch on cap opening
- Digital timer
- Smooth design for easy cleaning
- Timer settings between 1 and 30 seconds

DIMENSIONS

H150 x W200 x D210mm

BA Optima U-Mix Capsule Mixer

Code	Description
BASE800	BA Optima U-Mix Capsule Mixer

BA Optima

Micromotor



BASE050

KEY FACTS

- Rechargeable and portable
- E-type motor: 0 - 30,000rpm
- Clips to belt/desktop
- Up to 8 hour battery life
- Variable speed control
- Right and left turning ability

1. BA Portable Micromotor

Code	Description
BASE050	Complete micromotor unit with controller & motor

2. Micromotor only

Code	Description
BASE010	Micromotor only with lead

3. Controller

Code	Description
BASE020	Controller only with charger



BA Optima

Extra-Oral Suction Unit



EOS350

B.A. International's high power Extra-Oral Suction system is designed to effectively capture droplets and airborne aerosols produced from dental treatments while ensuring patient comfort.

KEY FACTS

- HEPA 14 filter traps 99.995% of particles $\geq 0.3\mu\text{m}$ (H1 European standard EN779- 1993)
- Ultraviolet disinfectant system inactivates trapped viruses and bacteria
- Ultrastrong suction power (1.2kW motor and 3,000L/min volume)
- Rear mounted air vent at top of unit for exhaust air release
- Lightweight and easy to move between surgeries
- Quiet operation at 58db (air cond. volume)
- Adjustable power levels

BA Optima EOS350 & Accessories

Code	Description
BA183050	EOS350 Extra-oral suction unit
BA183510	Replacement HEPA filter
BA183550	Replacement fine filter
BA183560	Complete arm for EOS350

BA Supreme Lab Units & Handpieces



Handpieces sold separately

BA Supreme Lab Units & Handpieces

S50T

(Table Control only)

KEY FACTS

- Up to 50,000rpm • Digital display • No assembly required
- Speed selection 1000 – 50,000rpm • Counter-clockwise rotation up to 30,000rpm • Ergonomic and innovative design for efficiency • Built-in safety cut off switch

Technical Data: S50T

- Depth: 200mm.
- Width: 220mm.
- Height: 100mm.
- Weight: 3.5kg.

S50T BA Supreme Lab Unit (Table Control)

Code	Description
BA190060	S50T Supreme Lab Unit (handpiece not included)

S50K

(Knee Control only)

KEY FACTS

- Up to 50,000rpm • Digital display • Speed adjustment continuous by knee lever with sensor • Speed selection 1000 – 50,000rpm
- Simple and immediate assembly • Counter-clockwise rotation up to 30,000rpm • Ergonomic and innovative design for efficiency • Built-in safety cut off switch

Technical Data: S50K

- Depth: 230mm.
- Width: 300mm.
- Height: 100mm.
- Weight: 3.3kg.

S50K BA Supreme Lab Unit (Knee Control)

Code	Description
BA190055	S50K Supreme Lab Unit (handpiece not included)

S50F

(Foot Control only)

KEY FACTS

- Up to 50,000rpm • Speed selection 1000 – 50,000rpm
- Ergonomic and innovative design for efficiency • Simple and immediate assembly • Counter-clockwise rotation up to 30,000rpm

Technical Data: S50F

- Depth: 250mm.
- Width: 220mm.
- Height: 100mm.
- Weight: 3.5kg.

S50F BA Supreme Lab Unit (Foot Control)

Code	Description
BA190050	S50F Supreme Lab Unit (handpiece not included)

S50N

BA Supreme lab handpiece

KEY FACTS

- Lightweight • Runs smoothly and quietly • High grip strength
- Powerful torque 7.8Ncm • Concentricity <0.02mm • Brushless

Technical Data: S50N

- Length: 156mm.
- Diameter: max. 28mm.
- Torque: 7.8Ncm.
- Weight: 220g.

Code	Description
BA190070	Handpiece for Supreme lab Units

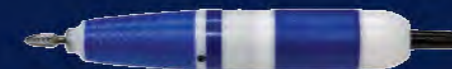

S50H

BA Supreme heavy duty lab handpiece

KEY FACTS

- Lightweight • Runs smoothly and quietly • High grip strength
- Powerful torque 8.9Ncm • Concentricity <0.02mm • Brushless

Technical Data: S50H

- Length: 159mm.
- Diameter: max. 30mm.
- Torque: 8.9Ncm.
- Weight: 389g.

Code	Description
BA190065	Heavy duty handpiece for Supreme lab Units



Made in Germany

BA Supreme Lab Units & Handpieces



Handpiece included

BA Supreme Lab Units & Handpieces

B30K

KEY FACTS

- Brushed DC type lab unit with handpiece
- Maximum efficiency, low noise and vibration
- FWD/REV function
- Usage memory and storage function
- "Self-diagnosis" function with error display

Technical Data: Unit

- Max. 45,000rpm
- Depth: 90mm.
- Width: 235mm.
- Height: 200mm.
- Weight: 2.3kg.

Technical Data: Handpiece

- Max. 45,000rpm.
- Torque: 4.0Ncm.
- Length: 164mm.
- Weight: 233g.

Code	Description
BA190110	B30K Supreme Lab Unit (handpiece included)
BA190145	H45 Handpiece

B50K

KEY FACTS

- Brushless DC type lab unit with handpiece
- Maximum efficiency, low noise and vibration
- FWD/REV function
- Usage memory and storage function
- "Self-diagnosis" function with error display

Technical Data: Unit

- Max. 50,000rpm.
- Depth: 90mm.
- Width: 235mm.
- Height: 200mm.
- Weight: 2.4kg.

Technical Data: Handpiece

- Max. 50,000rpm.
- Torque: 7.0Ncm.
- Length: 171mm.
- Weight: 202g.

Code	Description
BA190120	B50K Supreme Lab Unit (handpiece included)
BA190125	H50 Handpiece

B50T

KEY FACTS

- Strong torque at low speed
- Digital display
- FWD/REV functions
- "Self-diagnosis" function with error display
- Usage memory & storage function

Technical Data: Unit

- Max. 50,000rpm.
- Depth: 207mm.
- Width: 96mm.
- Height: 182mm.
- Weight: 2.5kg.

Technical Data: Handpiece

- Max. 50,000rpm.
- Torque: 7.0Ncm.
- Length: 171mm.
- Weight: 202g.

Code	Description
BA190130	B50T Supreme Lab Unit (handpiece included)
BA190125	H50 Handpiece

H45/H50



Code	Description
BA190145	H45 Handpiece



Code	Description
BA190125	H50 Handpiece

BA Extreme

Lab Motor



BA Extreme B150T

New electric high-speed lab motor with up to 150.00RPM, designed especially for efficient trimming of zirconia ceramic.

KEY FACTS

- Electric high speed motor specialized for zirconia trimming
- Up to 150.000RPM at the motor
- Brushless motor technology minimizes vibration
- Direct water spray function
- LED light
- Anti-dust mechanism
- Two-layer detachable motor design
- Includes high-speed brushless electric handpiece

Technical Data: Unit

- Max. 150.000RPM
- Width: 115mm
- Depth: 210mm
- Height: 270mm
- Weight: 3.65kg

Technical Data: Handpiece

- Max. speed 150.000RPM
- Max. torque: 4.0 N.cm
- Dimensions: Ø25 x 101mm (L)
- Bur: FG bur, Ø1.6mm
- Optic: Yes
- Internal water spray: Yes

BA Extreme B150T

Code	Description
BA190200	B150T Complete Lab Motor (handpiece included)
BA190250	Handpiece only for B150T



Powerful electric handpiece

The electric handpiece with its powerful torque is extremely efficient for processing zirconia – up to 4 times faster.



Direct water spray function

The unit has an internal water tank and allows for direct supply from a supply hose. The spray function helps prevent cracks in your work.

Dual-function: Wet & Dry

Option of turning spray on/off for both wet and dry methods.

LED light

The LED light provides a better view of the working area.



Anti-dust mechanism

The handpiece's anti-dust mechanism prevents dust particles entering the handpiece, providing more durability.



BA Supreme

Steamer



S5

KEY FACTS

- Stainless steel tank: 5lt, 4.5 bar • Professional insulation system to maintain heat and save energy • Copper heating element: 1500W
- Safety cap with Teflon and silicone seal (premium safety for heating and pressure) • Works with normal water • Water level indicator • Red indicator for low water level

Technical Data:

S5 BA Supreme Steamer 5 IT

- Length: 220mm.
- Width: 330mm.
- Height: 335mm.
- Power: 200 Watt.
- Weight: 13kg.

Code	Description
BA190030	Supreme Steamer 5 IT 1500W

Made in Italy

BA Supreme

Curing Unit



S300

KEY FACTS

A high capacity light-curing device for curing dental materials like universal trays, composites and block-out materials. The polymerisation chamber offers sufficient room for up to 4 models. Due to the semi-circular arrangement of each 2 UVA fluorescent lamp and blue fluorescent lamp, a homogeneous polymerisation light for a reliable and uniform curing of the materials is provided. Times of polymerisation (LED display) can be selected: 5 minutes, 10 minutes or continuous.

Technical Data:

S300 Supreme Light-Curing Unit

- Depth: 250mm.
- Width: 245mm.
- Height: 170mm.

Code	Description
BA190020	S300 BA Supreme Light Curing Light

Made in Germany

BA Supreme

Lab Vibrator



S230

KEY FACTS

The BA Lab Vibrator has been developed for vibrating and compacting investments, plasters or similar materials. This procedure improves the homogeneity of the product and eliminates air bubbles that could be generated while mixing and melting the product.

Technical Data:

S230 BA Lab-Vibrator medium

- Length: 240mm.
- Width: 155mm.
- Height: 100mm.
- Power: 200 Watt.
- Weight: 5.1kg.

Code	Description
BA190010	S230 BA Lab-Vibrator medium

Made in Italy

BA

LED Bulbs

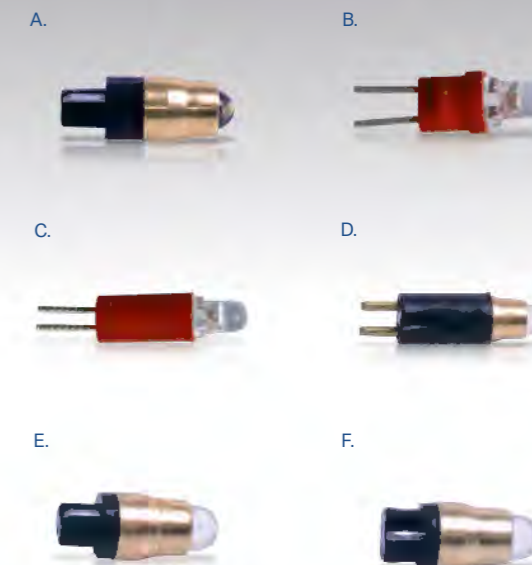

BA LED

KEY FACTS

- A cost-effective way to switch your handpieces to LED light.
- Much longer life than normal Halogen bulbs • No heat generation
- Less energy consumed • Working voltage: 3.6V • Eye-friendly light

BA LED Bulbs

Code	Description
A. BALEDN	For BA560 KaVo® fitting coupling
B. BALEDBM	For Bien Air® MC3 type micromotor
C. BALEDT	For Bien Air® turbines
D. BALEDNL	For BA565/BA565LED and NSK® PTL type couplings
E. BALEDS	For Sirona® f/o couplings and BA695LW/LB and BA755LW/LB turbines
F. BALEDK	For KaVo® non-LED f/o coupling, BA360LED KaVo® type coupling

BA

Multigauge



BA

Steritube



Maintenance

Handpiece Guide

Handpiece Care and Maintenance	68
Decontamination Cycle	71

KEY FACTS

4-hole multigauge to measure:

- Drive air • Exhaust air • Water • Spray air

BA Multigauge

Code	Description
BA08010030	4-hole multigauge

KEY FACTS

- New and innovative • Protects your handpieces from scratches • Autoclavable
- Reusable, stackable and durable

BA Steritube

Code	Description
S150B	Yellow autoclavable tube



BA International Handpiece Care and Maintenance guide

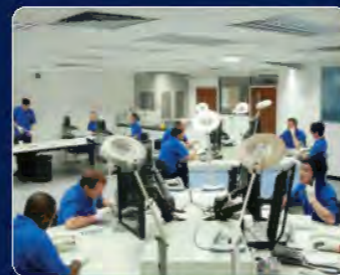

High speed turbine, contra-angle and straight handpiece care and maintenance guide

Manual cleaning

Clean the external body of the instrument under cool running water.

We recommend you use cool running water using a dedicated brush. The water must not exceed 38°C and be of at least drinking quality.

Never clean in an ultrasonic bath!

Automated processing in a DAC is preferable over manual cleaning. If you have a thermal washer disinfectant, then please refer to your handpiece manual prior to placing handpieces in the thermal washer disinfectant.

Disinfecting

Wipe the body of the handpiece with an appropriate disinfectant wipe.

Do not submerge in a disinfectant solution.

Oil nozzles

Connect the appropriate nozzle for the handpiece to the oil canister (see page 32 for correct nozzles). Shake the spray can vigorously.

Lubrication and internal cleansing

Holding the can upright, insert the nozzle into the base of the handpiece. Spray for 1-2 seconds into a tissue covering the handpiece head (or until the excess oil being blown into the tissue runs clean).

Wipe off any excess surface oil with a dry tissue. If any debris or residue is visible, repeat this process until the oil in the tissue runs clear.

In order to preserve the function of the chuck system, the collet chuck should be lubricated regularly by spraying lubricant directly into the collet.

Storing

For bagging your handpieces prior to autoclaving, you may wish to use the BA Ultiseal/Ultra Seal Pro bagging devices (page 50).

Sterilising

Put the handpieces into the autoclave. Select the correct cycle. Do not use a drying cycle in a non vacuum autoclave.

CAUTION!

Do not subject quick couplings to sterilisation! As soon as the sterilisation cycle has finished, remove the handpieces from the autoclave. Do not leave them overnight.

Maintenance Process



Additional cleaning and checks that can be carried out

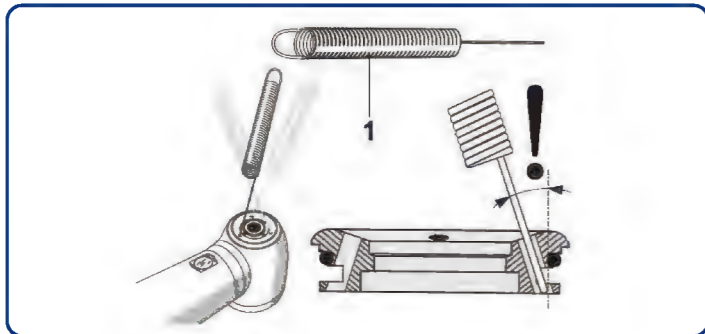

Cleaning the cooling spray jets

If calcareous tap water is used, the cooling spray jets may be partially or fully clogged due to calcification.

We therefore recommend that you regularly clean the jet openings carefully with the cleaning wire provided (1). Then let the turbine run briefly with cooling spray.

Thermodisinfection:

Many B.A. International handpieces can be thermodisinfected in a suitable thermodisinfector. The thermodisinfector used must be approved by its manufacturer for the thermodisinfection of turbine handpieces and comply with EN ISO 15883-1 (e.g. 95°C (203°F) and 10 min. holding time).



CAUTION! After every thermodisinfection the instrument must first be blown out and then treated with oil spray. Do not subject quick couplings to thermodisinfection!

If the device is still soiled after thermodisinfection, the process must be repeated.

The instrument must be completely free from residues and dry prior to any further conditioning.



Automated cleaning using the BA DAC or Nitram DAC

CAUTION! Always manually process the chucks of the instruments, even when automated processing is used, as described in the section "Cleaning the push-button chuck".

Cleaning, care and disinfection - We recommend using the BA DAC or Nitram DAC Universal for automated cleaning, care and disinfection of all our handpieces. For further details, please refer to the operating instructions supplied with the unit.

CAUTION! Do not subject quick couplings to automated cleaning!

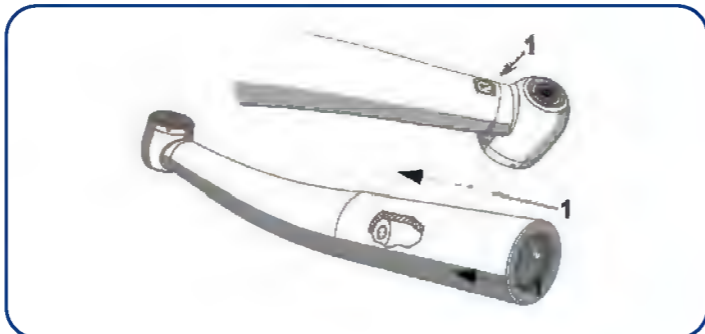

Cleaning the light guide surfaces

In order to avoid scratching the surfaces (1), blow off any dirt particles with air using a dry syringe.

Prior to sterilising, wipe off the surfaces with a cotton swab or a soft cloth and alcohol.

For further advice on the care and maintenance of your dental handpieces and small equipment, please contact us and we will be more than pleased to help.

Decontamination Cycle

Below is the Decontamination cycle that we recommend you follow. If you make sure each one of these sections is carried out fully, then you will prolong the life of your dental handpieces. Again, ensure you are wearing correct protective barrier clothing prior to commencing the cycle.



Once the decontamination cycle is complete, store the handpieces in accordance with local guidelines. BA International recommend that you visually check the handpieces for any damage before and after every procedure. Also adhere to the BA International instruction manuals for a more thorough guide on reprocessing your handpieces.

All BA International handpieces can be autoclaved and carry this sign:

If you are using a Thermo Washer Disinfector (TWD), then please ensure that the handpiece you are placing into the TWD carries this sign:



Dealer name and details:



B.A. International, Unit 7-10, Kingsthorpe Business Centre, Studland Road, Kingsthorpe, Northampton NN2 6NE, England

☎ +44 (0)1604 777 700 ✉ sales@bainternational.com 🖥 bainternational.com

B.A. International reserve the right to correct clerical omissions and errors in this brochure. All pictures in this publication are for illustration purposes only. KAVO® and MULTIflex LUX® are registered trademarks of Kaltenbach and Voigt GmbH & Co., Germany. Sirona® is a registered trademark of Sirona Dental Systems GmbH, Germany. NSK® is a registered trademark of Nakanishi Inc, Japan. EMS® is a registered trademark of E.M.S. Electro Medical Systems S.A., Switzerland. W&H® is a registered trademarks of W&H Dentalwerk Bürmoos GmbH, Austria. Bien-Air® is a registered trademarks of Bien-Air Dental S.A., Switzerland. N.B. B.A. International standard terms and conditions apply. © 2023 B.A. International, Unit 9, Kingsthorpe Business Centre, Studland Road, Kingsthorpe, Northampton NN2 6NE, England. E & O E. **BA0296-04-23**